



SBC300 Session Border Controller

User Manual V2.0



Shenzhen Dinstar Co., Ltd.

Address: Floor 18, Building 7A, Vanke Cloud City Phase 1, Xingke 1st Street, Xili Sub-district, Nanshan District, Shenzhen.

Postal Code: 518052

Telephone: +86 755 61919966

Fax: +86 755 26456659

Emails: sales@dinstar.com, support@dinstar.com

Website: www.dinstar.com

Preface

Welcome

Thanks for choosing **SBC300 Session Border Controller**! We hope you will make full use of this rich-feature device. Contact us if you need any technical support: 86-755-26456110/112.

About This Manual

This manual gives introduction to the SBC300 device, and provides information about how to install, configure or use it. Please read the manual carefully before installing it.

Intended Audience

This manual is primarily aimed at the following people:

- Users
- Engineers who install, configure and maintain SBC300 device

Revision Record

Document Name	Document Version	Firmware Version
SBC300 Session Border Controller User Manual	V1.0 (2019/07/12)	1.92.4.0

Conventions

Device mentioned in this document refers to the SBC300 Session Border Controller. Those words specially noted in the document are the contents that users need to pay attention to.

Contents

1 Production Introduction	1
1.1 Overview	1
1.2 Application Scenario	1
1.3 Product Appearance.....	2
1.4 Description of LED Indicators.....	2
1.5 Functions and Features.....	3
1.5.1 Key Features	3
1.5.2 Physical Interfaces	3
1.5.3 Capabilities	4
1.5.4 VoIP.....	4
1.5.5 Voice.....	5
1.5.6 Security	5
1.5.7 Call Control.....	5
1.5.8 Maintenance	6
1.5.9 Environmental.....	6
2 Installation	7
2.1 Preparations before Installation	7
2.1.1 Attentions for Installation.....	7
2.1.2 Preparations about Installation Site	7
2.1.3 Installation Tools	7
2.1.4 Unpacking	8
2.2 Installtion of SBC300.....	8
2.2.1 Put SBC300 into Shelf	8
2.2.2 Connect SBC300 to Network.....	8
2.2.3 How to make RJ45 Network Cable.....	8
2.2.4 Troubleshooting about Network Connection	9
3 Configurations on Web Interface	11
3.1 How to Log in Web Interface	11
3.1.1 Preparations for Login.....	11
3.1.2 Log in Web Interface.....	12
3.2 Introduction to Web Interface.....	13

3.3 Configuration Flows.....	14
3.3.1 System Status	15
3.3.2 Access Network Status	18
3.3.3 Access Trunk Status	19
3.3.4 Core Trunk Status.....	20
3.3.5 Calls Status.....	21
3.3.6 Register Status.....	21
3.3.7 Attack List.....	22
3.3.8 SIP Account Status	23
3.3.9 Statistics	23
3.3.10 Monitor Status.....	25
3.3.11 CDR Status.....	25
3.3.12 BFD Status	26
3.4 Service.....	26
3.4.1 Access Network.....	26
3.4.2 Access SIP Trunk	31
3.4.3 Core SIP Trunk.....	37
3.4.4 Routing Profile.....	42
3.4.5 Media Detection.....	46
3.4.6 CDR	47
3.4.7 Codec Profile.....	47
3.4.8 Number Profile.....	49
3.4.9 Black & White List	50
3.4.10 Number Manipulation	51
3.4.11 Number Pool	53
3.4.12 SIP Account.....	54
3.4.13 Time Profile.....	55
3.4.14 Rate Limit	56
3.4.15 SIP Header Manipulation	57
3.4.16 SIP Header Passthrough	59
3.4.17 Quality Monitoring	60
3.4.18 Bandwidth Limit	63
3.5 Security	63
3.5.1 System Security.....	63
3.5.2 Access Control	64
3.5.3 Security Policy	66
3.5.4 Tacacs Authentication Configuration	68
3.6 System.....	68

3.6.1 System Management	69
3.6.2 Web Configuration	69
3.6.3 Network.....	69
3.6.4 Port Mapping.....	72
3.6.5 Static Route	73
3.6.6 User Manager	73
3.6.7 Date & Time.....	75
3.6.8 Upgrade.....	75
3.6.9 Backup & Restore	76
3.6.10 Double-device Hot Standby	77
3.6.11 License	77
3.6.12 Certificate.....	77
3.7 Maintenance	78
3.7.1 Log.....	78
3.7.2 Reset.....	80
3.7.3 Ping	81
3.7.4 Tracert	81
3.7.5 Capture.....	82
3.7.6 Regular Expression	83
3.7.7 Warning	84
3.7.8 SNMP Configuration.....	85
4 Abbreviation	87

1 Production Introduction

1.1 Overview

With the rapid development of unified communication and All-IP network, more and more enterprises begin to construct their own IP-based communication system by using IP-PBX and software to improve internal communication efficiency. However, they need to ensure the NAT traversal for IP multimedia services and the safe access of users. Dinstar SBC300 session border controller can help enterprises to solve the abovementioned problem.

Dinstar SBC300 provides rich SIP-based services such as safe network access, robust security, system interconnectivity, flexible session routing & policy management, QoS, media transcoding and media processing for enterprises. With distributed multi-core processor, hardware structure for non-blocking gigabit switch system as well as embedded Linux operating system, SBC300 delivers high capability while achieves low power dissipation. It is able to process up to 300 concurrent SIP sessions and transcode 100 concurrent calls. Meanwhile, it allows encrypted sessions via TLS and SRTP. Apart from traditional codecs like G.729, G.723, G.711 and G.726, SBC300 also supports the transcoding of iLBC, AMR and OPUS.

1.2 Application Scenario

The application scenario of SBC300 session border controller is shown as follows:

Figure 1-1 Application Scenario of SBC300

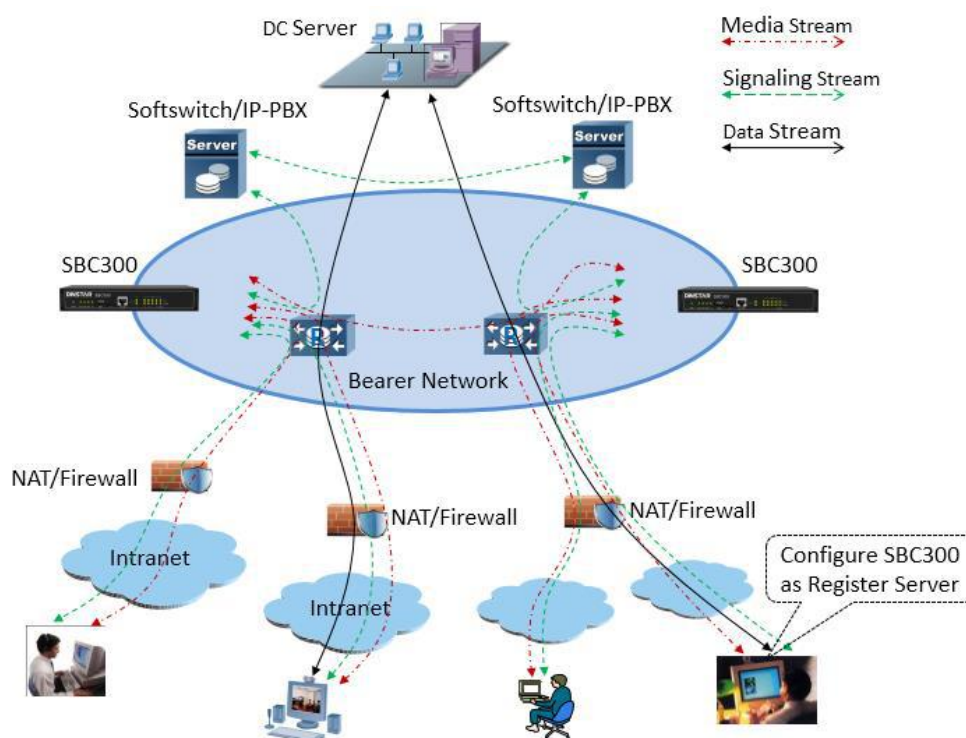

1.3 Product Appearance

Front View:



Back View:

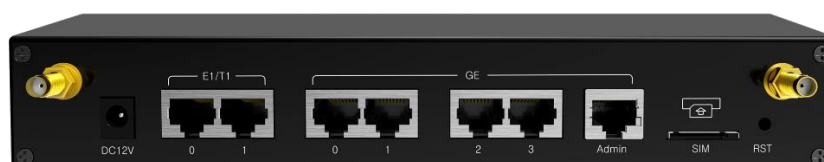

1.4 Description of LED Indicators

Indicator	Definition	Status	Description
PWR	Power Indicator	Off	There is no power supply or power supply is abnormal
		On	The device is powered on
RUN	Running Indicator	Slow Flashing (1s)	The device is initialized successfully and is running normally
		Fast flash for two times, with interval of 1s	Image file is upgraded successfully
		Fast Flashing (200ms)	Image file fails to be upgraded
		Other Statuses	The device is in abnormal running
GE/Admin	Link indicator (Green)	Fast Flashing	The network port is connected normally
		Off	The network port is not connected, or is connected abnormally
	Speed Indicator (Yellow)	On	Network port works at 1000Mbps
		Off	Network port works 10/100Mbps
E1/T1	E1/T1 Status Indicator	Reserved	Reserved
SIM	SIM Card Indicator	Reserved	Reserved
TF	TF Card Indicator	Reserved	Reserved

1.5 Functions and Features

1.5.1 Key Features

- Support up to 3000 SIP registrations, with maximum RPS (registrations per second) of 20/s
- Forward 300 media calls, with maximum forwarding rate of 20/s
- Transcode 120 media calls or faxes
- Encrypted sessions through SRTP and ‘SIP over TLS’
- Support multiple softswitches, anti-blocking and topology hiding
- SIP trunks & flexible routing rules for accessing IMS
- Support regular expression and black/white list
- Embedded VoIP firewall, prevention of DoS and DDoS attacks
- Prevention of address spoofing, prevention of illegal SIP/RTP packages
- Bandwidth limitation and dynamic white list & black list
- Bandwidth limitation and dynamic white list & black list
- IPv4/IPv6
- VLAN, QoS, static route, NAT traversal
- Double-device Hot Standby (Active-Standby Mode)
- Hierarchical management of users, import & export of remote upgrade and configuration data
- User-friendly web interface, multiple management ways
- Support SIP protocols including UDP, TCP and TLS
- Support multiple codecs: : G.711A/U,G.723.1,G.729A/B, iLBC, AMR, OPUS
- Support multiple softswitches
- WebRTC gateway (to do)
- Video service (to do)

1.5.2 Physical Interfaces

- Ethernet Ports:
 - 4* 10/100/1000M Base-T Ethernet ports (GE0-GE3 for services)
 - 1* 10/100/1000M Base-T Admin port (for management)
- E1/T1 Ports:
 - 2* E1/T1, RJ48C
- 1* USB 2.0
- 1* TF Card Slot

- Serial Console
1* RS232, 115200bps, RJ45
- LTE Uplink (to do)

1.5.3 Capabilities

- Concurrent Calls
Support 300 SIP sessions at maximum
- Transcoding
Supports 100 transcoding calls
- CPS for call
20 calls per second at maximum
- Registrations
Maximum SIP registrations: 3000
- CPS for Registration
20 registrations per second
- SIP Trunks
128 SIP trunks at maximum

1.5.4 VoIP

- IPv4 & IPv6
- SIP 2.0 compliant, UDP, TCP, TLS,
- SIP trunk (Peer to peer)
- SIP trunk (Access)
- SIP registrations
- B2BUA (Back-to-Back User Agent)
- SIP Request rate limiting
- SIP registration rate limiting
- SIP registration scan attack detection
- SIP call scan attack detection
- SIP anti-attack
- SIP Header manipulation
- SIP malformed packet protection

- Multiple Soft-switches supported
- QoS (ToS, DSCP)
- NAT Traversal

1.5.5 Voice

- Codecs: G.711a/μ, G.723, G.729A/B, iLBC, G.726, AMR, OPUS
- RTP Transcoding
- Fax: T.38 and Pass-through
- No RTP detection
- One-way audio detection
- RTP/RTCP
- RTCP statistics reports
- DTMF: RFC2833, SIP Info, INBAND
- Silence Suppression
- Comfort Noise
- Voice Activity Detection (VAD)
- Echo Cancellation(G.168, 128ms)
- Adaptive Dynamic Buffer

1.5.6 Security

- Prevention of DoS and DDos attacks
- Control of access policies
- Policy-based anti-attacks
- Call Security with TLS/SRTP
- White List & Black List
- Access Rule List
- Embedded VoIP Firewall

1.5.7 Call Control

- Dynamic load balancing and call routing
- Flexible routing engine
- Call routing based on prefixes
- Call routing based on caller/called number

- Regular Expression
- Call routing based on time profile
- Call routing based on SIP URI
- Call routing based on SIP method
- Call routing based on endpoint
- Caller/called number manipulation

1.5.8 Maintenance

- Web-based GUI for Configurations
- Configurations Restore/Backup
- HTTP Firmware Upgrade
- CDR Report and CDR Export
- Ping and Tracert
- Network Capture
- System Logs
- Statistics and Reports
- Multiple Languages
- Centralized Management System
- Remote Web and Telnet
- SNMP

1.5.9 Environmental

- Power Supply: DC12V 2A
- Power Consumption: 10w
- Operating Temperature: 0 °C ~ 45 °C
- Storage Temperature: -20 °C ~80 °C
- Humidity: 10%-90% Non-Condensing
- Dimensions (W/D/H): 226×146×39mm
- Unit Weight: 0.85 kg
- Compliance: CE, FCC

2 Installation

2.1 Preparations before Installation

2.1.1 Attentions for Installation

Before you install the SBC300 device, please read the following safety guidelines:

- To guarantee SBC300 works normally and to lengthen the service life of the device, the humidity of the equipment room where SBC300 is installed should be maintained at 10%-90% (non-condensing), and temperature should be 0 °C ~ 45 °C;
- Ensure the equipment room is well-ventilated and clean;
- It's suggested that personnel who has experience or who has received related training be responsible for installing and maintaining SBC300;
- Please wear ESD wrist strap when installing SBC300;
- Please do not hot plug cables;
- It's advised to adopt uninterruptible power supply (UPS).

2.1.2 Preparations about Installation Site

- Equipment Cabinet

Ensure the cabinet is well-ventilated and strong enough to bear the weight of SBC300.

- Trunk

Ensure telecom operator has approved to open a trunk.

- IP Network

Ensure router under IP network has been prepared, since SBC300 is connected to the IP network through the standard 10/100/1000M Ethernet port.

2.1.3 Installation Tools

- Screwdriver
- ESD wrist strap
- Ethernet cables, power wires, telephone wires

- Hub, telephone set, fax, and small PBX
- Terminal (can be a PC which is equipped with hyperterminal simulation software)

2.1.4 Unpacking

Open the packing container to check whether the SBC300 device and all accessories have been in it:

- One SBC300 device
- One power adapter: 12V, 2A
- Two network cables
- One Serial console cable
- Screws

2.2 Installtion of SBC300

2.2.1 Put SBC300 into Shelf

1. Put the SBC300 device on the shelf or cabinet horizontally;

2.2.2 Connect SBC300 to Network

SBC300 has five network ports, namely the gigabit network port for services (from GE0 to GE3) and the gigabit network port for network management (Admin). It is advised to connect GE0, GE1, GE2 or GE3 to the IP network.

Both GE0/GE1/GE2/GE3 and Admin can be used to carry out management on SBC300, but generally GE0/GE1/GE2/GE3 are put in use. Admin is used when there is a need to separate management-related processing from service processing on SBC300.

2.2.3 How to make RJ45 Network Cable

Step1. Prepare a twisted-pair cable with a length of at least 0.6 meters, and then remove the shuck of the network cable;

Step2. Sequence the wires of the cable according to EIA / TIA 568B Standard (as shown in the following figure);



Wire sequence of 568B: white & orange, orange, white & green, blue, white & blue, green, white & brown, brown.

Step3. Put the wires into the PINs of a RJ45 joint according to the abovementioned wire sequence of EIA/TIA 568B, and then use a wire crimper to crimp the RJ45 joint.

Step4. On the other end of the network cable, sequence the wires of the cable according to EIA/TIA 568A Standard (as shown in the following figure);

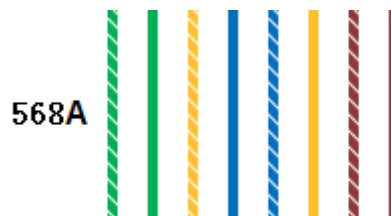

Wire sequence of 568A: white & green, green, white & orange, blue, white & blue, orange, white & brown, brown.

Step5. Put the wires into the PINs of a RJ45 joint according to the abovementioned wire sequence of EIA/TIA 568A, and then use a wire crimper to crimp the RJ45 joint.

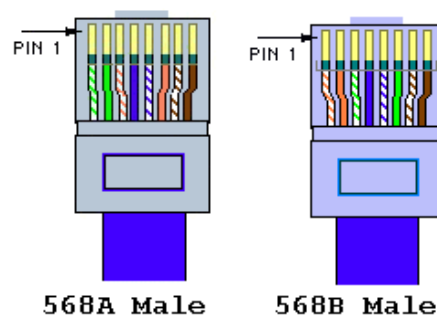

Step6. Test the usability of the network cable.

2.2.4 Troubleshooting about Network Connection

When the SBC300 device has been connected to gigabit Ethernet, but the SPEED and LINK indicators on the front panel of the device are still dull, it can be concluded that network connection fails.

You can try to find the reasons for network connection failure according to the following steps.

Step1: In case that the network cable is inserted into one of the service ports, please pull out the network cable and insert it into the ‘Admin’ port. If the indicator for the ‘Admin’ port is on, it can be concluded that the corresponding service port is faulty.

In case that the network cable is inserted into the ‘Admin’ port, please pull out the network cable and insert it into one of the service ports. If the indicator for the corresponding service port is on, it can be concluded that the ‘Admin’ port is faulty.

Step2: If the corresponding indicator is still dull after the network cable is inserted into other network port, please connect the network cable to a laptop or a PC, and then go to visit a website.

Step3: If the laptop or PC can visit a website normally, it can be concluded that the network cable is usable but the network port of SBC300 is faulty.

Step4: If the laptop or PC cannot visit a website, it can be concluded that the network cable is unavailable.

3 Configurations on Web Interface

3.1 How to Log in Web Interface

3.1.1 Preparations for Login

SBC300 has five network ports, namely the gigabit network ports for services (from GE0 to GE3) and the gigabit network port for management (Admin). It is advised to connect GE0/GE1/GE2/GE3 to the IP network.

The default IP address of the 'Admin' port is 192.168.11.1, while those of GE0, GE1, GE2 and GE3 are 192.168.12.1, 192.168.13.1, 192.168.14.1 and 192.168.15.1 respectively.

First Use

At the first time that the SBC300 device is put in use, please connect the device's Admin port to a PC by using a network cable, and then modify the IP address of the PC to make it at the same network segment with of the default IP address of the Admin port. The format of PC IP address is 192.168.11.XXX, since the default IP of Admin port is 192.168.11.1

Daily Use

Connect the service port (GE0/GE1/GE2/GE3) of SBC300 to a 1000Mbps or 10/100Mbps switch.

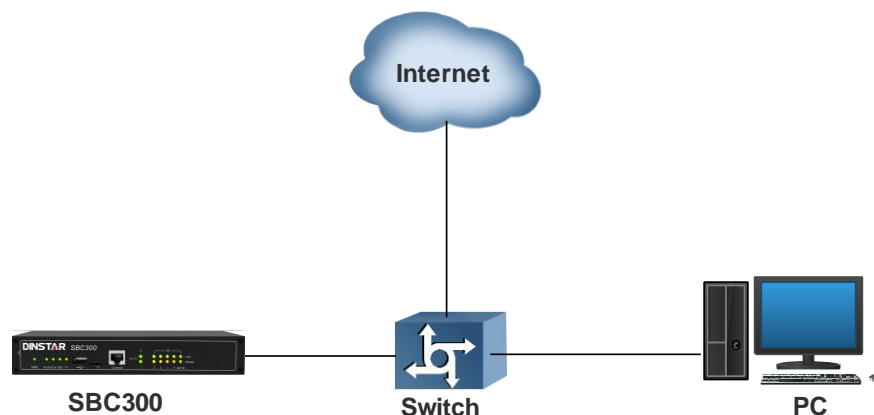

If SBC300 is connected to a 1000Mbps switch, the link indicators on the front panel turn green and flash, while the speed indicators turn yellow.

If SBC300 is connected to a 10/100Mbps switch, the link indicators on the front panel turn green and flash, while the speed indicators remain dull.

Note:

At the first time that the SBC300 device is used, only the Admin port is allowed to visit the Web interface (other network ports are disabled). If you want to connect the SBC300 device through other network ports, please connect the Admin port to a PC and log into the Web interface of the device, and then enable GE0, GE1, GE2 and GE3 ports on the **Security**→**Access Control** page.

3.1.2 Log in Web Interface

Open a web browser and enter the IP address of the Admin port of SBC300 (https:// 192.168.11.1). Then input username, password and verification code on the displayed login GUI. The default username is admin, while the default password is `admin@123#`.

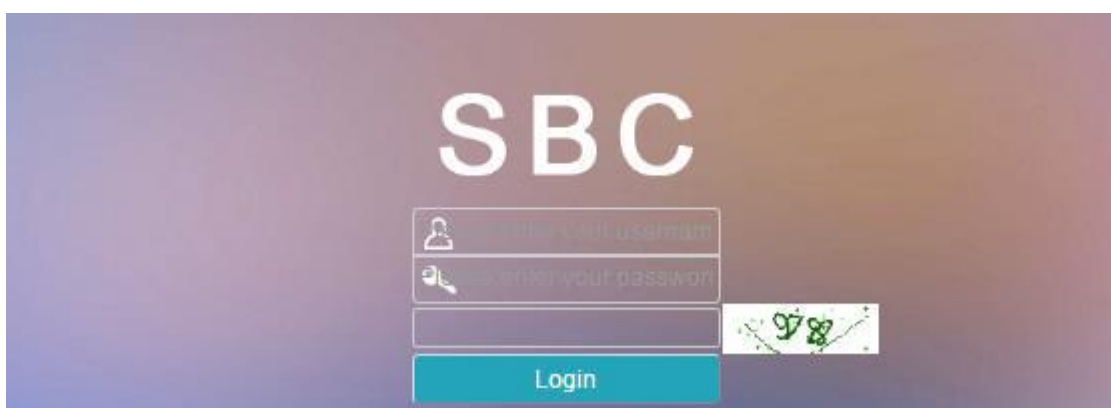

Figure 3-1 Login GUI

For security consideration, it is suggested that you should modify the username and password on the **System** → **Users** page.

Old Password

New Password

Password Strength

Confirm

Figure 3-2 Modify Password

Note:

1. If you forget the IP address after modification and cannot log in the Web interface, please use a serial cable to connect the Console port of SBC300 with a PC. Enter the 'en' mode and input 'show interface' to query the IP address.
2. The verification code on the login GUI will refresh automatically every 15 minutes.
3. After you log into the Web, if you are carrying out configurations on the pages of the web, the web will not log out automatically. On the "System → Web Configuration" page, you can set the auto exit time, which means the web will log out automatically after the time expires. The maximum auto exit time is 480 minutes.

3.2 Introduction to Web Interface

The Web Interface of the SBC300 consists of the main menu bar, navigation tree and detailed configuration interfaces. Click a button of the main menu bar and select a node of the navigation tree on the left, you will see a detailed display interface or configuration interface:

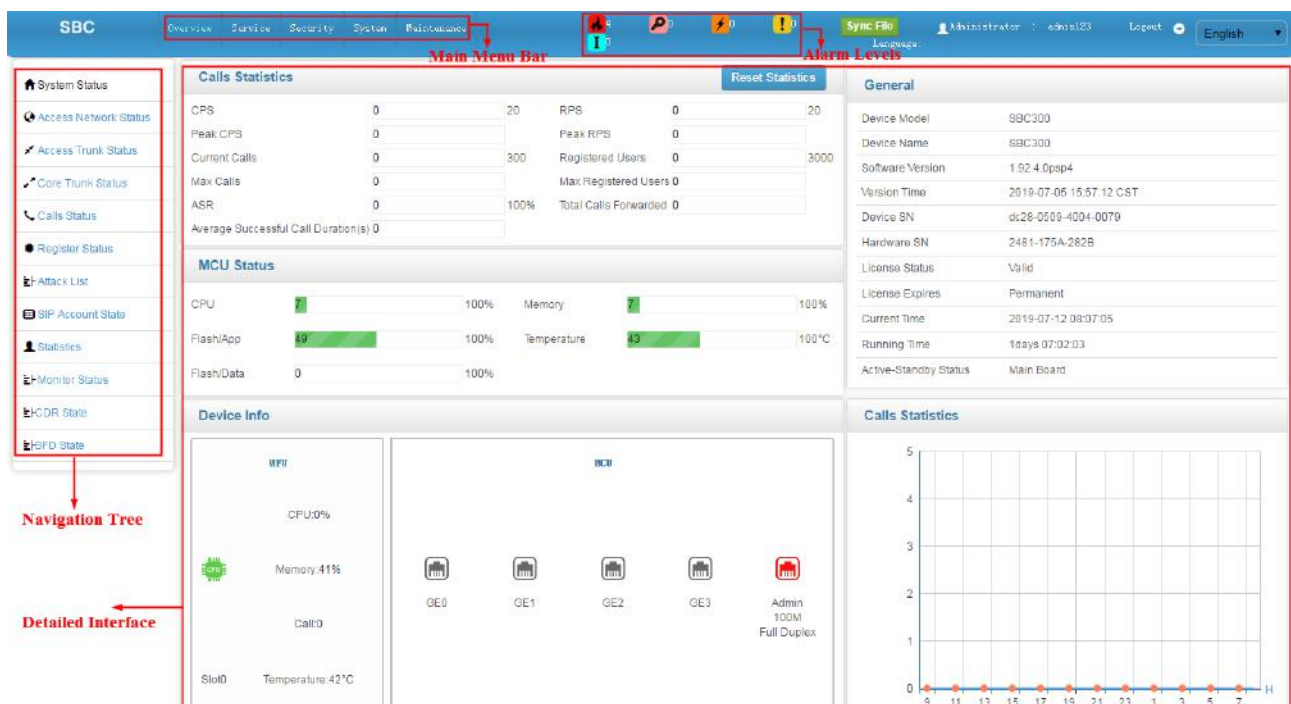











Figure 3-3 Structure of Web Interface

Table 3-1 Introduction to Web Interface

Index	Item	Description
1	Main Menu Bar	The main menu bar of SBC300, including buttons of Overview, Service, Security, System and Maintenance
2	Navigation Tree	The navigation tree of each button of the main menu bar

3	Detailed Interface	The detailed configuration interface or display interface of a node under navigation tree
4	Alarm Levels	The following alarm levels are related to service, security and system.  :Emergent  :Critical  :Alert  :Warning
5	Sync File	 : When two SBC300 devices work under the active-standby mode, click this button, and then the files will be synchronized between the active device and the standby device. When the SBC device does not work under the active-standby mode, this button does not work.
6	Language	Choose Chinese or English
7	Logout	Click logout, and you will exit the Web interface
8	  Admin 100M GE1 1000M	If the port displayed on the “Overview→System Status” page turns red, it means the network works at 100Mbps. If it turns green, it means the network works at 1000Mbps.
6		To add configurations
7		To edit or modify configurations
8		To delete configurations

3.3 Configuration Flows

The following is the general configuration flows of SBC300:

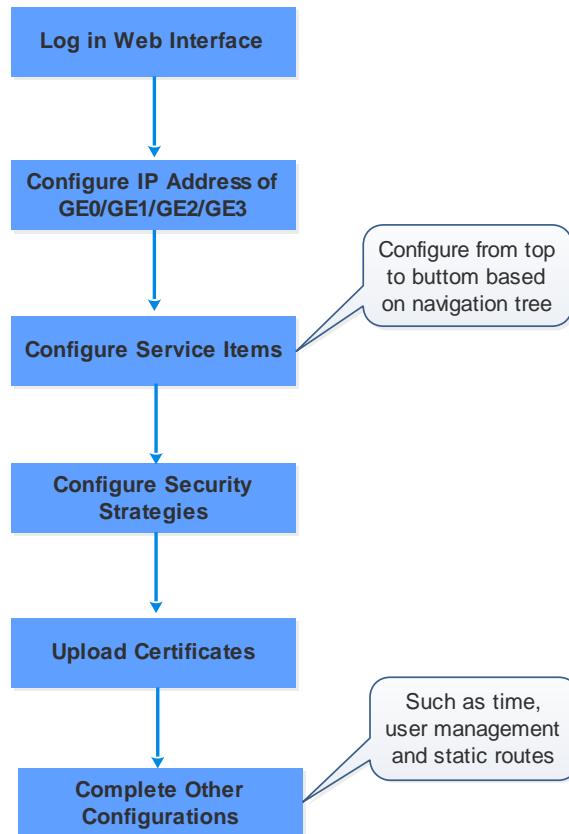

Figure 3-4 Configuration Flow

3.3.1 System Status

Log into the Web interface, and the 'System Status' page is displayed. On the page, call statistics and its graphic, device information, MCU (Main Control Unit) status as well as general information are shown.

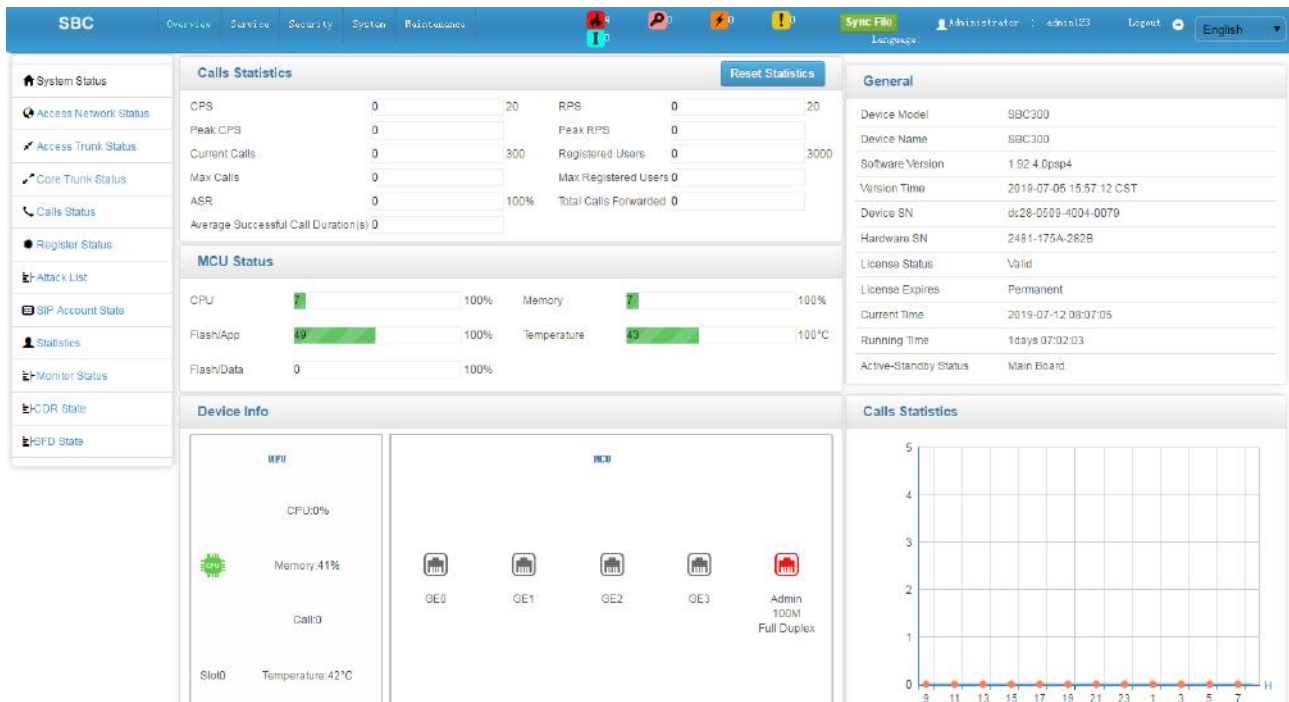

Figure 3-5 System Status

Table 3-2 Calls Statistics

CPS (Calls Per Second)	The number of new calls going through SBC300 every second at current time
Peak CPS	The peak CPS (calls per second) since SBC300 is booted up
Current Calls	The number of on-going calls at current time
Max. Calls	The maximum number of concurrent calls since SBC300 is booted up
ASR	ASR (Answer Success Rate) is a call success rate in telecommunication, which reflects the percentage of answered telephone calls with respect to the total call volume. ASR = answered call/total attempts of calls.
Average Successful Cal Duration (s)	The average duration of successful calls
RPS (Registrations Per Second)	The number of new requests for registrations every second at current time
Peak RPS	The peak RPS (registrations per second) since SBC300 is booted up
Registered Users	The total number of registered users at current time
Max. Registered Users	The maximum number of registrations that are simultaneously processed since SBC300 is booted up
Total Calls Forwarded	The total number of legal call requests since SBC300 is booted up

Table 3-3 MCU Status

CPU	The CPU occupancy rate at current time
Flash/App	The occupancy rate of application flash at current time
Flash/Data	The occupancy rate of data flash at current time
Memory	The occupancy rate of memory at current time
Temperature	The temperature of the CPU for MCU (Main Control Unit)

Table 3-4 Device Information

MFU (Main Function Unit)	CPU	The CPU occupancy rate of MFU at current time
	Memory	The memory occupancy rate of MFU at current time
	Call	The number of current calls that are being processed by MFU's CPU
	Temperature	The temperature of the CPU for MFU
MCU (Main Control Unit)	Network Ports (Admin/GE0/GE1/GE2/GE3)	All the network ports on the MCU, among which the green one means that it is working at 1000 Mbps, while gray ones are idle. If one port is red, it means it is working at 100Mbps.

Table 3-5 General Information

Device Model	SBC300
Device Name	The name of the device, which can be modified on the 'System →System Management' page
Software Version	The current software version No. running on SBC100
Version Time	The time when the running version is put in use
Device SN	The SN of the SBC300 device
License Status	If the license is in its validity period, "Valid" will be displayed. If the license has expired, "Invalid" is shown
License Expires	The remaining time of license validity
Current Time	The current time of SBC300, which can be modified or synchronized on the 'System →Date & Time' page
Running time	The running time of the device since it is booted up
Active-Standby Status	When 'main board' is displayed, it means the current SBC300 device is the active device under the active-standby mode.

Note:

If the current time is still wrong after the system time has been synchronized or the device is restarted, it means the battery inside the device runs low and you need to replace the battery with a new one. Besides, only the Admin port can be used to synchronize time with NTP.

3.3.2 Access Network Status

Terminal users are registered to SBC300 through access network. The status of access network is always “true”, which means the access network is normal and available.

On the **Overview** → **Access Network Status** page, detailed information about access network, including the status, name, CPS (Calls Per Second), number of registered users, ASR (Answered Success Ratio), number of calls that are being transcoded, number of current calls as well as number of total calls, are shown.

Name	Status	CPS	Registered Users	Inbound Calls				Outbound Calls				
				ASR	Transcoded	Cur. Calls	Total Calls	ASR	Transcoded	Cur. Calls	Total Calls	
IAD_Endpoints	true	0	0	0	0	0	0	0	0	0	0	0

Figure 3-6 Access Network Status

Table 3-6 Access Network Status

Name	The name of the access network. It cannot be changed after the configuration is successfully applied
Status	The status of access network is always “true”, which means the access network is normal and available
CPS	The number of new calls going through the access network every second at current time
Registered	The total number of users that are successfully registered through the access network and are still in validity period
ASR	The ASR of the access network since the device is booted up; ASR = successful calls/total legal calling attempts
Transcoding	The number of calls that are being transcoded in the access network at current time
Current Calls	The number of current calls in the access network
Total Calls	The total number of legal calls since the device is booted up

Note:

Calls are grouped into inbound calls and outbound calls. Inbound calls go from terminal users to SBC300, while outbound calls are exactly the opposite.

Inbound calls and outbound calls have their own statistics of ASR, number of transcoded calls, number of current calls and number of total calls.

3.3.3 Access Trunk Status

Access SIP Trunk can realize the connection between terminal users and SBC300.

If both 'Registration' and 'Keepalive' are disabled for the SIP trunk on the **Service → Access SIP Trunk** page, the status of the SIP trunk will be 'True'. If both 'Registration' and 'Keepalive' are enabled, the SIP trunk is successfully registered and meanwhile the option message for 'Keepalive' is successfully responded, the status of the SIP trunk will be 'True', otherwise, the status will be 'False'.

If only 'Registration' is enabled and meanwhile the SIP trunk is successfully registered, the status of the SIP trunk will be 'True', otherwise, the status will be 'False'. If only 'Keepalive' is enabled and meanwhile its option message is successfully responded, the status of the SIP trunk will be 'True', otherwise, the status will be 'False'.

Name	Status	CPS	Inbound Calls				Outbound Calls					
			ASR	Transcoded	Cur. Calls	Total Calls	Registered	ASR	Transcoded	Cur. Calls	Total Calls	
AccessTrunk_Bob	false	0	0	0	0	0	0	0	0	0	0	0
AccessTrunk_Tom	true	0	0	0	0	0	0	0	0	0	0	0

Figure 3-7 Access Trunk Status

Table 3-7 Access Trunk Status

Name	The name of the access SIP trunk. It cannot be changed after the configuration is successfully applied
Status	The status of the access SIP trunk. True: the access SIP trunk is connected normally and available; False: the access SIP trunk is disconnected and unavailable
CPS (Calls Per Second)	The number of new calls directed by the access SIP trunk every second at current time
ASR	The ASR of the access SIP trunk since the device is booted up; ASR = successful calls/total legal calling attempts
Transcoded	The number of calls that are being transcoded through the access SIP trunk at current time
Current Calls	The number of current calls routed by the access SIP trunk
Total Calls	The total number of legal calls routed by the access SIP trunk since the device is booted up
Registered	The total number of users that are successfully registered to SBC300 by the help of the access SIP trunk and are still in validity period

Note:

As for ASR, if the invite message of a call is successfully responded, we consider the call as a successful/answered call.

Calls are grouped into inbound calls and outbound calls. Inbound calls go from terminal users to SBC300, while outbound calls are exactly the opposite. Inbound calls and outbound calls have their own statistics of ASR, number of transcoded calls, number of current calls and number of total calls.

3.3.4 Core Trunk Status

Core network's SIP trunk can realize the connection between the core network and SBC300.

If both 'Registration' and 'Keepalive' are disabled for the SIP trunk, the status of the SIP trunk will be 'True'. If both 'Registration' and 'Keepalive' are enabled, the SIP trunk is successfully registered and meanwhile the option message for 'Keepalive' is successfully responded, the status of the SIP trunk will be 'True', otherwise, the status will be 'False'.

If only 'Registration' is enabled and meanwhile the SIP trunk is successfully registered, the status of the SIP trunk will be 'True', otherwise, the status will be 'False'. If only 'Keepalive' is enabled and meanwhile its option message is successfully responded, the status of the SIP trunk will be 'True', otherwise, the status will be 'False'.

Name	Status	CPS	Inbound Calls				Outbound Calls					
			ASR	Transcoded	Cur. Calls	Total Calls	Registered	ASR	Transcoded	Cur. Calls	Total Calls	
3cx	true	0	0	0	0	0	0	0	0	0	0	0

Figure 3-8 Core Trunk Status

Table 3-8 Core Trunk Status

Name	The name of the core SIP trunk. It cannot be changed after the configuration is successfully applied
Status	The status of the core SIP trunk. True: the core SIP trunk is connected normally and available; False: the core SIP trunk is disconnected and unavailable
CPS (Calls Per Second)	The number of new calls routed by the core SIP trunk every second at current time
Registered	The total number of users that are successfully registered to SBC300 by the help of the core SIP trunk and are still in validity period
ASR	The ASR of the core SIP trunk since the device is booted up; ASR = successful calls/total legal calling attempts
Transcoded	The number of calls that are being transcoded through the core SIP trunk at current time
Current Calls	The number of current calls routed by the core SIP trunk
Total Calls	The total number of legal calls routed by the core SIP trunk since the device is booted up

Note:

As for ASR, if the invite message of a call is successfully responded, we consider the call as a successful/answered call.

Calls are grouped into inbound calls and outbound calls. Inbound calls go from core network to SBC300, while outbound calls are exactly the opposite. Inbound calls and outbound calls have their own statistics of ASR, number of calls that are being transcoded, number of current calls and number of total calls.

3.3.5 Calls Status

On the **Overview** → **Calls Status** page, the statuses, durations, caller number and callee number of current calls are displayed.

Status	RTP Port	Duration(s)	Name	Source				Destination				Peer IP		
				Caller	Callee	Codec	RTP	Name	Caller	Callee	Codec		RTP	
outgoing	33454	-	tg51	17052359348	4200208	PCMA	0/0	192.168.2.64:10828	tg28	17052359348	4200208	0/0	.0	
answer	33016	24	tg51	17052350486	4200227	PCMA	998/998	192.168.2.64:9996	tg28	17052350486	4200227	G729	999/998	172.30.60.124:12812
answer	32768	24	tg51	17052357891	4200465	PCMA	998/998	192.168.2.64:9992	tg28	17052357891	4200465	G729	998/998	172.30.60.124:12808
answer	33752	24	tg51	17052351419	4200955	PCMA	998/998	192.168.2.64:9990	tg28	17052351419	4200955	G729	998/998	172.30.60.124:12806
answer	33350	24	tg51	17052358142	4200231	PCMA	998/998	192.168.2.64:9988	tg28	17052358142	4200231	G729	998/998	172.30.60.124:12804
answer	32792	24	tg51	17052358672	4200172	PCMA	998/998	192.168.2.64:9986	tg28	17052358672	4200172	G729	998/997	172.30.60.124:12802
answer	33632	24	tg51	17052354911	4200424	PCMA	998/998	192.168.2.64:9984	tg28	17052354911	4200424	G729	998/998	172.30.60.124:12800
answer	32956	25	tg51	17052352527	4200762	PCMA	998/998	192.168.2.64:9854	tg28	17052352527	4200762	G729	998/998	172.30.60.124:12670

Figure 3-9 Calls Status

Table 3-9 Call Status

Status	<p>Init: an invite request for calling is received and the call is initiated;</p> <p>Outgoing: the request for routing out the call is sent , and the system is waiting for response</p> <p>Early: the 18x response is received</p> <p>Completed: the 2xx response is received, and the system is waiting for the ack message</p> <p>Answer: the ack message is received, and the call is set up</p>
RTP Port	The local RTP port of the call. If the RTP port is displayed as '0', it means the RTP session has not been connected successfully
Duration(s)	The duration of the call
Name	The name of the call, which will be used when the call goes through access network's SIP trunk, core network's SIP trunk or access network
Caller	The caller number of the call
Callee	The callee number of the call
Codec	The codec adopted by the call. If it is a transcoded call, the source codec is different from the destination codec
RTP	The number of RTP messages that received or sent. The statistics is collected every five seconds
Peer IP	The peer IP address and peer RTP port

3.3.6 Register Status

On the **Overview** → **Register Status** page, the registration statuses of terminal users on SBC300 are displayed.

Figure 3-10 Register Status

Table 3-10 Register Status

Status	Registering: SBC300 has received the registration request send by terminal user, and is processing the request; Registered: The terminal user has been successfully registered and is in validity period
Username	The username of the terminal user, which will be used during registration
Name	Name (source): refers to the name of the access network where the registered terminal user is from; Name (destination): refers to the name of the core network's SIP trunk where the registration goes to
Reg. Interval	Register Interval (source): the interval of registering to SBC300 by terminal user Register Interval (destination): the interval of registering to core network's SIP trunk by SBC300
IP Addr./NAT	IP Addr./NAT (source): the IP address and NAT address of terminal user IP Addr./NAT (destination): the IP address and NAT address of core network's SIP trunk

3.3.7 Attack List

On the **Overview** → **Attack List** page, the source, IP address and interface of attacks to SBC300 are shown.

Figure 3-11 Attack List

Table 3-11 Attack List

Source	The source of an attack inflicted on SBC300, for example, DDoS/DoS attacks
IP: Port	The IP address of the attack source, or the destination port that is attacked
Interface	The SBC300 device's network interface that is attacked, for example, GE1
Traffic	The traffic of the attack. When the traffic here mounts to the traffic threshold set on the Security → Security Policy page, the action such as 'Drop' or 'Flow Limited' will be executed.
Action	Log Record: when the security policy is triggered and takes effect, the attack event is recorded in a log Flow Limited: when the security policy is triggered and takes effect, the traffic of peer IP address or the set local port is limited, and those packets whose traffics exceed are dropped during the protection time.

	<p>Packet Rate Limited: when the security policy is triggered and takes effect, the packet rate of peer IP address or the set local port is limited, and those packets with exceeding transmission rate are dropped during the protection time.</p> <p>Drop: when the security policy is triggered and takes effect, all the packets from peer IP address and those received by the set local port are dropped during the protection time.</p>
Protection Time	The duration of the action conducted on attack source

3.3.8 SIP Account Status

On the **Overview** → **SIP Account Status** page, the statuses of the SIP accounts that have been used for registration are displayed. If a SIP account is registered successfully, its status will be ‘registered’, otherwise its status is ‘registering’.

SIP accounts are added on the **Service** → **SIP Account** page, and their registrations are configured on the **Service** → **Access SIP Trunk** page or the **Service** → **Core SIP Trunk** page.

Index	Status	Name	Username	Endpoint	Current Concurrence	Max Concurrence	Times of Use
1	registering	Account_1	bob account1	2	0	1	0

Figure 3-12 SIP Account Status

3.3.9 Statistics

On this section, statistics about flow, call and hang-up reason are displayed.

Current and historical flow data is shown as follows:

Name	Type	Time	Rx	Tx
1	Endpoint	2019-07-16 10:00:00	0Byte	0Byte
2	Endpoint	2019-07-16 10:00:00	2 GB 70 MB 97 KB 808 Byte	2 GB 84 MB 819 KB 1016 Byte
D222_51	Endpoint	2019-07-16 10:00:00	3 GB 644 MB 685 KB 544 Byte	3 GB 805 MB 306 KB 304 Byte
T20_97	Endpoint	2019-07-16 10:00:00	2 GB 84 MB 819 KB 1016 Byte	2 GB 70 MB 97 KB 808 Byte

Figure 3-13 Current Flow Data

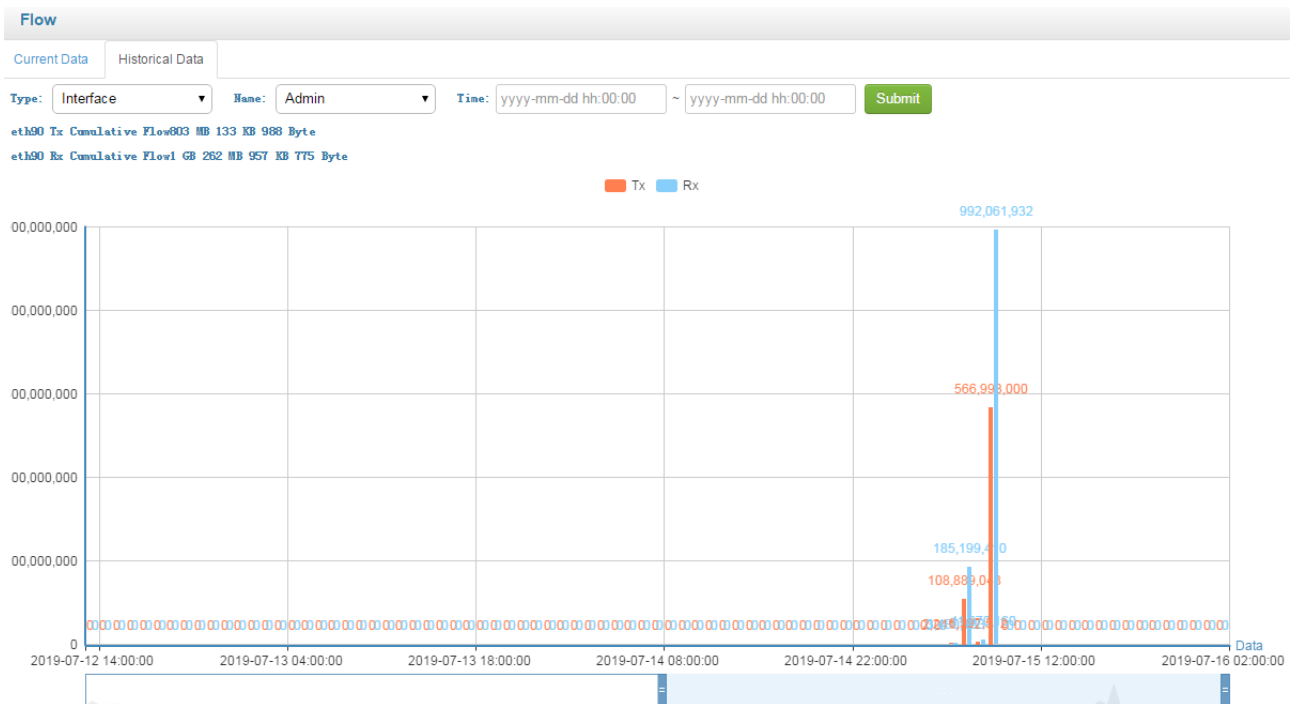

Figure 3-14 Historical Flow Data

Call data is displayed as follows:

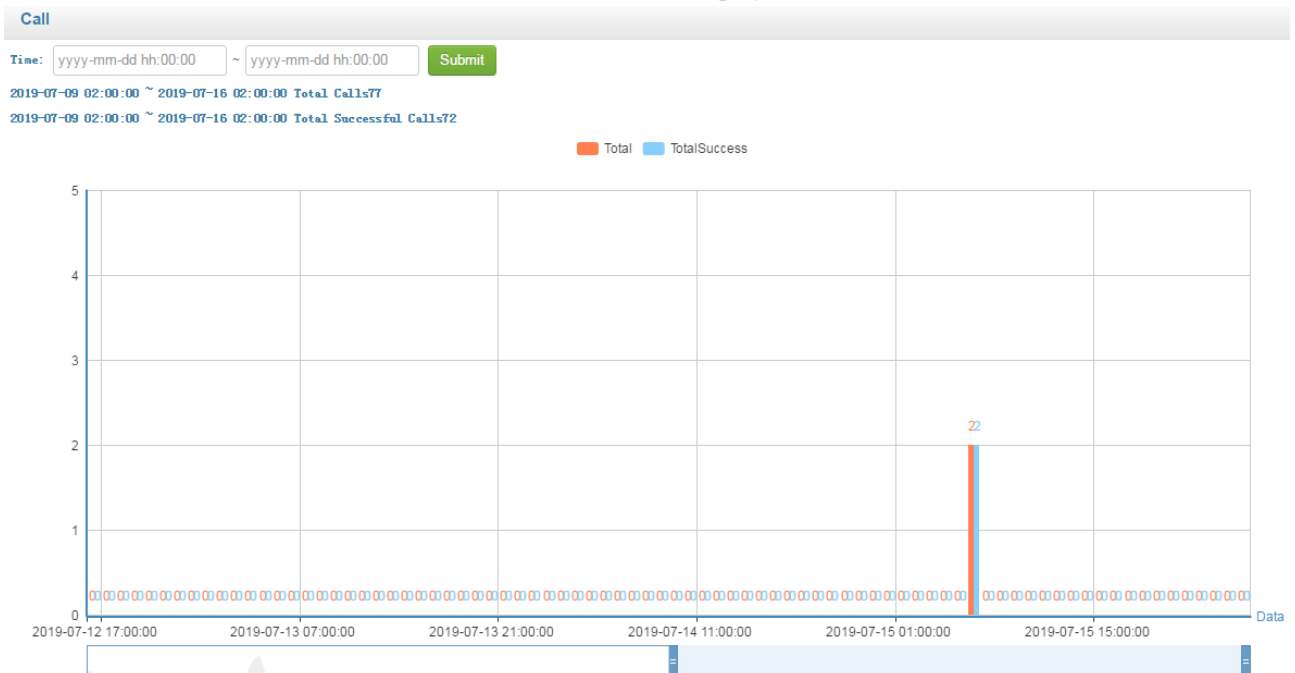

Figure 3-15 Call Data

Statistics about hand-up reasons are shown as follows:

Hang Up Reason

Hang Up Reason	
Normal Call Clearing(200)	8589888
Temporarily Unavailable(480)	0
Forbidden(403)	0
Not Found(404)	0
Busy Here(486)	392163
Internal Server Error(500)	745647
Server Time Out(504)	0
Service Unavailable(503)	60
Others	134020

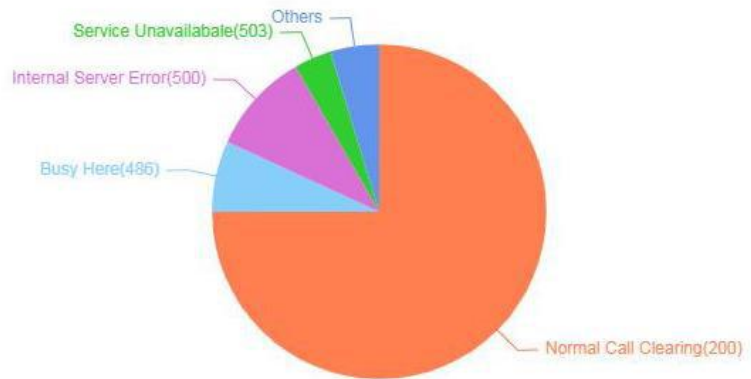

Figure 3-16 Statistics about Hang-up Reasons

3.3.10 Monitor Status

On the **Overview** → **Monitor Status** page, information about the RTP packets related to current calls are shown. Only those current calls that conform to the criteria configured on the **Service** → **Quality** Monitoring page are monitored.

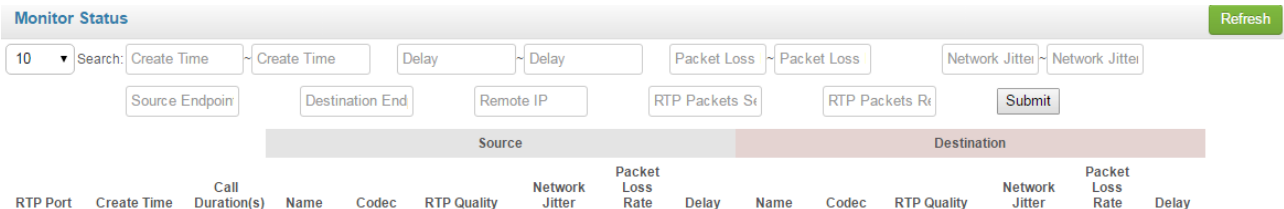

Figure 3-17 Monitor Status

3.3.11 CDR Status

On the **Overview** → **CDR Status** page, you can see the CDRs that are saved on the local database of the SBC 300 device, and you can search specific CDRs and export them. On the **Service** → **CDR** page, the CDR server defaults to 'Disabled', and you need to enable it. Meanwhile, you need to select the checkbox on the right of 'Local DB'.

On this page, you can also export CDRs. The Exported CDRs are in the format of csv or txt.

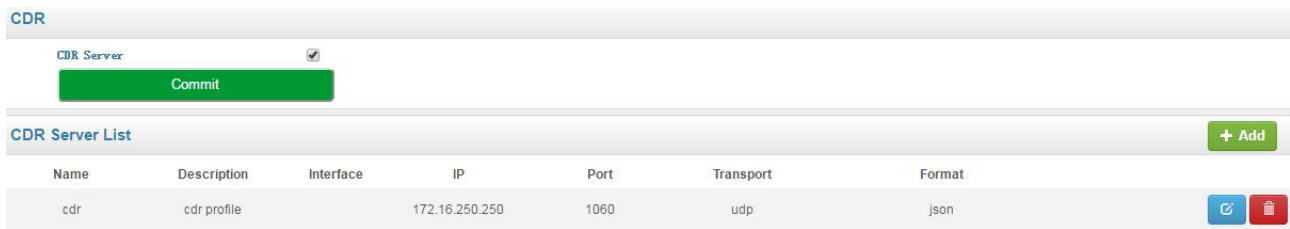

Figure 3-18 CDR Status

3.3.12 BFD Status

When two SBC devices work under the active-standby mode, BFD is used to check the links between the active and the standby SBC devices.

BFD (Bidirectional Forwarding Detection) is an internet protocol intended to detect faults in the bidirectional path between two forwarding engines, including interfaces, data link(s), and to the extent possible the forwarding engines themselves, with potentially very low latency.

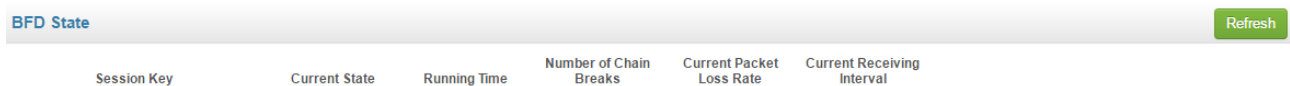

Figure 3-19 BFD Status

3.4 Service

3.4.1 Access Network

On the **Service** → **Access Network** page, you can configure the parameters of access network, which will be used when terminal users are registered to softswitch through the SBC300 device.

ID	*	<input type="text" value="2"/>
Name	*	<input type="text" value="Bob2"/>
Description		<input type="text" value="Bob's access network"/>
Valid		<input checked="" type="checkbox"/>
<hr/>		
Interface		<input type="text" value="GE0"/>
media interface		<input type="text" value="GE0"/>
Transport		<input type="text" value="UDP"/>
Port	*	<input type="text" value="5060"/>
IPv4/IPv6		<input type="text" value="IPV4"/>
IP Range		<input type="text"/> ~ <input type="text"/>
Subnet Mask		<input type="text"/>
Codec		<input type="text" value="default"/>
DTMF		<input type="text" value="RFC2833"/>
RFC2833	*	<input type="text" value="101"/>

Advanced ^	
Bandwidth Limit	Total Amount of <input type="text" value="Mbit/s"/>
Signaling DSCP	<input type="text" value="BE"/>
Audio Media DSCP	<input type="text" value="BE"/>
Video Media DSCP	<input type="text" value="BE"/>
Near-end NAT	<input type="text"/>
Refresh Media Penetration	<input checked="" type="checkbox"/>
Respond to Media Refresh	<input type="checkbox"/>
Initial Invite Message Carrying SDP	<input type="checkbox"/>

Domain Filter

+ Domain Filter

Rate Limit: default

Blacklist:

Whitelist:

Inbound Manipulation:

Inbound SIP Header Manipulation:

Outbound SIP Header Manipulation:

SIP Session Timer: Disable

Min Register Interval: 180 s

HAT Expire: 60 s

PRACK: Disable

Peer Media Address: Lock

Refresh Remote Media Address: Enable

Peer Signaling Address: Unlock

Caller From: User

Callee From: User

SIP Methods:

- OPTIONS
- INFO
- REFER
- NOTIFY
- SUBSCRIBE
- UPDATE

Figure 3-20 Configure Parameters of Access Network

Table 3-12 Explanation of Parameters for Access Network

ID	The ID of the access network, used to identify this access network
Name	The name of the access network. It cannot be modified after the access network has been added successfully
Description	The description of the access network
Valid	The checkbox on the right is selected, the access network will become valid
Interface	The interface for signaling forwarding. It can be GE0, GE1, GE2 , GE3 or Admin
Media Interface	The interface for media forwarding. It can be GE0, GE1, GE2 , GE3 or Admin
Transport Protocol	Select a transport protocol for the access network. It can be UDP, TCP or TLS
SIP Port	The access network's SIP listening port on the Ethernet interface of SBC300

IPv4/IPv6	Select a network protocol for the access network. It can be IPv4 or IPv6. By default, the network protocol is IPv4
IP Range	Configure the range of legal IP addresses that are allowed to connect to this access network
Subnet Mask	The subnet mask of the IP range
Codec	The codecs that the access network supports. Please refer to 3.4.7
DTMF	DTMF is short for Dual Tone Multi Frequency; There are three DTMF modes, including SIP Info, INBAND, RFC2833; If the DTMF mode of an access network differs from that of core network, SBC300 will convert it through DSP
Advanced	
Bandwidth Limit	You can set the total amount of bandwidth in the box on the left, and choose a bandwidth limit profile on the right box. The bandwidth limit profile which illustrates what kind of packets will be limited need to be preset on the Service →Bandwidth page (3.4.18).
Signaling DSCP	The QoS tag of SIP signaling messages. It is 'BE' by default
Audio Media DSCP	The QoS tag of audio media messages. It is 'BE' by default
Video Media DSCP	The QoS tag of video media messages. It is 'BE' by default
Near-end NAT	Near-end NAT defaults to disabled. If it is enabled, the contact IP address contained in SIP messages sent out by SBC300 will be turned into the outbound IP address of public network. If NAT is enabled, you need to fill in the outbound IP address of public network.
Refresh Media Penetration	If this parameter is enabled and the user terminal connected to this access network refreshes media messages such as codec, the refresh will be penetrated to this access network
Respond to media refresh	If this parameter is enabled, the access network will respond to the media refresh
Initial Invite Message carrying SDP	If this parameter is enabled, initial invite message will carry SDP by default
Domain Filter	
Rate Limit	The maximum RPS (registrations per second), CPS (calls per second) and total call volume. Please refer to 3.4.14
Blacklist	Select a blacklist for the access network. Calls given by the caller numbers on the blacklist will be refused to go through the access network. Please refer to 3.4.9

Whitelist	Select a whitelist for the access network. Calls initiated by the caller numbers on the whitelist will be allowed to go through the access network. Please refer to 3.4.9 . If no black list and white list are selected for the access network, all calls are allowed to go through the access network
Inbound Manipulation	Select a number manipulation rule or a number pool for the access network. When a call coming into the access network matches the manipulation rule, its number will be manipulated. Please refer to 3.4.10 3.4.10 and 3.4.11 .
Inbound SIP Header Manipulation	Select a SIP header manipulation rule for inbound calls of the access network. If a call matches the manipulation rule, the SIP header of the messages related to the call will be manipulated when it comes into the access network. Please refer to 3.4.15
Outbound SIP Header Manipulation	Select a SIP header manipulation rule for outbound calls of the access network. If a call matches the manipulation rule, the SIP header of the messages related to the call will be manipulated when it goes out the access network. Please refer to 3.4.15
SIP Session Timer	Session timer is a mechanism to keep activating sessions. If 'Supported' is selected, SBC300 will send 'invite' messages to keep activating sessions within the configured duration. If no messages are detected within the configured duration, sessions will be considered as 'ended', and then will be disconnected. If 'Require' is selected, the callee side of a call passing through the access network also needs to support session timer.
Session Expire	Configure the duration of the session. During the duration, SBC300 will send 'invite' messages to keep activating the session.
Min. Session Timeout	Minimum session duration is used to negotiate with the session timer on the callee side
Min Register Interval	The minimum time allowed for terminal's registration. That is to say, if the 'expires' value in the REGISTER message is smaller than this minimum time, SBC300 will refuse the register request.
NAT Expire	If a terminal is in private network and sends out messages through NAT, the registration time responded by SBC300 will automatically turned into the time configured here. The value of 'NAT Expire'
PRACK	PRACK (Provisional Response ACKnowledgement): provide reliable provisional response messages. Disable: INVITE request and 1xx response sent out by SBC300 will not include <i>100rel</i> tag by default; Support: INVITE request and 1xx response sent out by SBC300 will include

	<p><i>100rel</i> tag in Supported header;</p> <p>Require: INVITE request and 1xx response sent out by SBC300 will include <i>100rel</i> tag in Require header; if the peer does not support 100rel, it will automatically reject INVITE request with 420; if the peer supports 100rel, it will send <i>PRACK</i> request to acknowledge the response.</p>
Peer Media Address	<p>Lock: when the peer device works at public network, media address carried in SDP (Session Description Protocol) message is locked; when the peer device works at private network, the address that sends 30 messages continuously are locked.</p> <p>Unlock: remote address sending media messages is not locked.</p>
Refresh Remote Media Address	<p>If this parameter is enabled, the remote address receiving media messages will be refreshed.</p>
Peer Signaling Address	<p>Lock: when a calling account is successfully registered, the access network only receives those calls from the registered address of the caller.</p>
Caller From	<p>User: the USER field of FROM header of INVITE message is extracted as caller number</p> <p>Display: the DISPLAY field of FROM header of INVITE message is extracted as caller number</p>
Callee From	<p>User: the USER field of TO header of INVITE message is extracted as callee number;</p> <p>Display: the DISPLAY field of TO header of INVITE message is extracted as callee number;</p> <p>Request-uri: the USER NUMBER in REQUEST-URI of INVITE message is extracted as callee number;</p>
SIP Methods	<p>Configure the SIP request methods that can be accepted by the access network.</p> <p>If a SIP request method is not enabled, the system will reject the corresponding SIP request.</p> <p>By default, the INVITE request, REGISTER request and SESSION DISCONNECT request are accepted.</p>

3.4.2 Access SIP Trunk

Access SIP trunk can realize the connection between access network and SBC300. On the **Service → Access SIP Trunk** page, you can configure the parameters of access SIP trunk.

ID	*	1
Name	*	James1
Description		James1
Valid		<input checked="" type="checkbox"/>
Interface		GE0
media interface		GE0
Transport		UDP
Port	*	5060
IPv4/IPv6		IPV4
Codec		default
DTMF		RFC2833
		RFC2833 * 101
Trunk Mode		Static
Remote IP :Port	*	172.16.0.2:5060

Advanced 	
Bandwidth Limit	Total Amount: Mbit/s <input type="text"/>
Signaling DSCP	BE <input type="text"/>
Audio Media DSCP	BE <input type="text"/>
Video Media DSCP	BE <input type="text"/>
Hear-end NAT	<input type="text"/>
Refresh Media Penetration	<input checked="" type="checkbox"/>
Respond to Media Refresh	<input type="checkbox"/>
Initial Invite Message Carrying SDP	<input type="checkbox"/>
Rate Limit	default <input type="text"/>
Blacklist	<input type="text"/>
Whitelist	<input type="text"/>
Inbound Manipulation	<input type="text"/>
Inbound SIP Header Manipulation	<input type="text"/>
Outbound SIP Header Manipulation	<input type="text"/>
Sip Account	<input type="text"/>
Remote Server Domain	<input type="text"/>
Access ACL table	<input type="text"/>
	<input type="button" value="+ Add"/>
Registration	<input type="checkbox"/>
Keepalive	<input type="checkbox"/>
SIP Session Timer	Disable <input type="text"/>
PRACK	Disable <input type="text"/>
Peer Media Address	Lock <input type="text"/>
Refresh Remote Media Address	Enable <input type="text"/>
Peer Signaling Address	Unlock <input type="text"/>
Caller From	User <input type="text"/>
Callee From	User <input type="text"/>
SIP Methods	<input checked="" type="checkbox"/> OPTIONS <input checked="" type="checkbox"/> INFO <input checked="" type="checkbox"/> REFER <input checked="" type="checkbox"/> NOTIFY <input checked="" type="checkbox"/> SUBSCRIBE <input checked="" type="checkbox"/> UPDATE

Figure 3-21 Configure Access SIP Trunk

Table 3-13 Access SIP Trunk

ID	The ID of the access SIP trunk, used to identify this access SIP trunk
Name	The name of the access SIP trunk. It cannot be modified after the access SIP trunk has been added successfully
Description	The description of the access SIP trunk
Valid	The checkbox on the right is selected, the access SIP trunk will become valid
Interface	The interface for signaling forwarding. It can be GE0, GE1, GE2 , GE3 or Admin
Media Interface	The interface for media forwarding. It can be GE0, GE1, GE2 , GE3 or Admin
Transport Protocol	Select a transport protocol for the access SIP trunk. It can be UDP, TCP or TLS
SIP Port	The access SIP trunk's listening port on the Ethernet interface of SBC300
IPv4/IPv6	Select a network protocol for the access SIP trunk. It can be IPv4 or IPv6. By default, the network protocol is IPv4
Codec	The codecs that the access SIP trunk supports. Please refer to 3.4.7
DTMF	DTMF is short for Dual Tone Multi Frequency; There are three DTMF modes, including SIP Info, INBAND, RFC2833
Trunk Mode	When SBC is connected to IMS, Static: you need to manually configure the IP address and port of the peer device, for example, 192.168.2.159:5060 Remote domain name: the domain name of the peer Dynamic: the access SIP trunk works as a server, and you need to configure username, authentication ID and password for the SIP trunk, which will be used when a peer device tries to register to the SIP trunk. If the peer device registers to the SIP trunk successfully, the status of the SIP trunk will be 'True'. If the peer device fails to register or does not register to the SIP trunk, the status of the SIP trunk will be 'False'.
Advanced	
Bandwidth Limit	You can set the total amount of bandwidth in the box on the left, and choose a bandwidth limit profile on the right box. The bandwidth limit profile which illustrates what kind of packets will be limited need to be preset on the Service →Bandwidth page (3.4.18).
Signaling DSCP	The QoS tag of SIP signaling messages. It is 'BE' by default
Audio Media DSCP	The QoS tag of audio media messages. It is 'BE' by default
Video Media DSCP	The QoS tag of video media messages. It is 'BE' by default
Near-end NAT	Near-end NAT defaults to disabled. If it is enabled, the contact IP address contained in SIP messages sent out by SBC300 will be turned into the outbound IP address of public

	<p>network.</p> <p>If NAT is enabled, you need to fill in the outbound IP address of public network.</p>
Refresh Media Penetration	If this parameter is enabled and the user terminal on one side of the SBC300 refreshes media messages such as codec, the refresh will be penetrated to the user terminal on the other side of the SBC300
Respond to media refresh	If this parameter is enabled, the SBC300 will respond to the media refresh
Initial Invite Message carrying SDP	If this parameter is enabled, initial invite message will carry SDP by default
Domain Filter	
Rate Limit	The maximum RPS(registrations per second), CPS(calls per second) and total call volume. Please refer to 3.4.14
Blacklist	Select a blacklist for the access SIP trunk. Calls given by the caller numbers on the blacklist will be refused to go through the access SIP trunk. Please refer to 错误!未找到引用源。
Whitelist	Select a whitelist for the access SIP trunk. Calls initiated by the caller numbers on the whitelist will be allowed to go through the access SIP trunk. Please refer to 3.4.9 If no black list and white list are selected for the access SIP trunk, all calls are allowed to go through the access SIP trunk
Inbound Manipulation	Select a number manipulation rule or a number pool for the access SIP trunk. When a call coming into the access SIP trunk matches the manipulation rule, its number will be manipulated. Please refer to 3.4.10 and 3.4.11
Inbound SIP Header Manipulation	Select a SIP header manipulation rule for inbound calls of the access SIP trunk. If a call matches the manipulation rule, the SIP header of the messages related to the call will be manipulated when it comes into the access SIP trunk. Please refer to 3.4.15
Outbound SIP Header Manipulation	Select a SIP header manipulation rule for outbound calls of the access SIP trunk. If a call matches the manipulation rule, the SIP header of the messages related to the call will be manipulated when it goes out the access SIP trunk Please refer to 3.4.15
SIP Account	Select a SIP account or a group of SIP accounts which will be bound (registered) to this access SIP trunk
Remote Server Domain	The domain of the remote server where this access SIP trunk is registered
Registration	If registration is enabled, the access SIP trunk will be registered to the configured remote server address, and the status of the access SIP trunk will become 'Ture'. Otherwise, the

	status is 'False'. For the status of access SIP trunk, please refer to 3.3.4 .
Username	The username used for registration; it's the same as configured in the remote server
Authentication ID	The authentication id used for registration; it's the same as configured in the remote server
Password	The password used for registration; it's the same as configured in the remote server
Registered Interval	The valid period of the registration, such as 1800s. It means you need to refresh the registration within 1800s.
Timeout coefficient	The parameter is used to determine when to refresh the registration. For example, if the 'Registered Interval' is 60s and the 'Timeout coefficient' is 1, the time to refresh the registration will be $60s * 0.8 * 1 = 48s$.
Keepalive	If 'Keepalive' is disabled, the SBC300 will not detect whether the access SIP trunk's remote device (generally it is the access network server) is reachable or not. If it is enabled, option message will be sent to detect the remote server in access network is reachable. If response is received, it means the remote server is reachable, and the status of the access SIP trunk is 'True'. Otherwise, the status will be 'False'. For the status of access SIP trunk, please refer to 3.3.3 .
SIP Session Timer	Session timer is a mechanism to keep activating sessions. If 'Supported' is selected, SBC300 will send 'invite' messages to keep activating sessions within the configured duration. If no messages are detected within the configured duration, sessions will be considered as 'ended', and then will be disconnected. If 'Require' is selected, the callee side of a call passing through the access SIP trunk also needs to support session timer.
Session Expire	Configure the duration of the session. During the duration, SBC300 will send 'invite' messages to keep activating the session.
Min. Session Timeout	Minimum session duration is used to negotiate with the session timer on the callee side
PRACK	PRACK (Provisional Response ACKnowledgement): provide reliable provisional response messages. Disable: INVITE request and 1xx response sent out by SBC300 will not include <i>100rel</i> tag by default; Support: INVITE request and 1xx response sent out by SBC300 will include <i>100rel</i> tag in Supported header; Require: INVITE request and 1xx response sent out by SBC300 will include <i>100rel</i> tag in Require header; if the peer does not support 100rel, it will automatically reject INVITE request with 420; if the peer supports 100rel. it will send <i>PRACK</i> request to acknowledge the response.

Peer Media Address	<p>Lock: when the peer device works at public network, media address carried in SDP (Session Description Protocol) message is locked; when the peer device works at private network, the address that sends 30 messages continuously are locked.</p> <p>Unlock: remote address sending media messages is not locked.</p>
Refresh Remote Media Address	If this parameter is enabled, the remote address receiving media messages will be refreshed.
Peer Signaling Address	Lock: when a calling account is successfully registered, the access SIP trunk only receives those calls from the registered address of the caller.
Caller From	<p>User: the USER field of FROM header of INVITE message is extracted as caller number</p> <p>Display: the DISPLAY field of FROM header of INVITE message is extracted as caller number</p>
Callee From	<p>User: the USER field of TO header of INVITE message is extracted as callee number;</p> <p>Display: the DISPLAY field of TO header of INVITE message is extracted as callee number;</p> <p>Request-uri: the USER NUMBER in REQUEST-URI of INVITE message is extracted as callee number;</p>
SIP Methods	<p>Configure the SIP request methods that can be accepted by the access SIP trunk;</p> <p>If a SIP request method is not enabled, the system will reject the corresponding SIP request.</p> <p>By default, the INVITE request, REGISTER request and SESSION DISCONNECT request are accepted.</p>

3.4.3 Core SIP Trunk

Core SIP trunk can realize the connection between SBC300 and the core network. On the **Service → Core SIP Trunk** page, you can configure the parameters of core SIP trunk.

ID *	1
Name *	2
Description	
Valid	<input checked="" type="checkbox"/>
Interface	Admin
media interface	Admin
Transport	UDP
Port *	5070
IPv4/IPv6	IPV4
Codec	default
DTMF	RFC2833
	RFC2833 * 101
Trunk Mode	Static
Remote IP :Port *	172.21.180.16:5060

	Advanced ^
Bandwidth Limit	0 Mbit/s
Signaling DSCP	BE
Audio Media DSCP	BE
Video Media DSCP	BE
Near-end NAT	
Refresh Media Penetration	<input checked="" type="checkbox"/>
Respond to Media Refresh	<input type="checkbox"/>
Initial Invite Message Carrying SDP	<input type="checkbox"/>
Inbound Manipulation	
Inbound SIP Header Manipulation	
Outbound SIP Header Manipulation	
Sip Account	Account 1
Matching Mode	Polling
Remote Server Domain	172.16.0.8
Access ACL table	<input type="button" value="+ Add"/>
Registration	<input type="checkbox"/>
Keepalive	<input type="checkbox"/>
SIP Session Timer	Disable
PRACK	Disable
Peer Media Address	Lock
Refresh Remote Media Address	Enable
Peer Signaling Address	Unlock
Caller From	User
Callee From	User

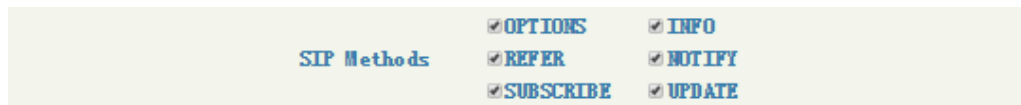

Figure 3-22 Core SIP Trunk

Table 3-14 Core SIP Trunk

ID	The ID of the core SIP trunk, used to identify this core SIP trunk
Name	The name of the core SIP trunk. It cannot be modified after the core SIP trunk has been added successfully
Description	The description of the core SIP trunk
Valid	The checkbox on the right is selected, the core SIP trunk will become valid
Interface	The interface for signaling forwarding. It can be GE0, GE1, GE2 , GE3 or Admin
Media Interface	The interface for media forwarding. It can be GE0, GE1, GE2 , GE3 or Admin
Transport Protocol	Select a transport protocol for the core SIP trunk. It can be UDP, TCP or TLS
SIP Port	The core SIP truck's listening port on the Ethernet interface of SBC300
IPv4/IPv6	Select a network protocol for the core SIP trunk. It can be IPv4 or IPv6. By default, the network protocol is IPv4
Codec	The codecs that the access SIP truck supports. Please refer to 3.4.7
DTMF	DTMF is short for Dual Tone Multi Frequency; There are three DTMF modes, including SIP Info, INBAND, RFC2833
Trunk Mode	When SBC is connected to IMS, Static: you need to manually configure the IP address and port of the peer device, for example, 192.168.2.159:5060 Remote domain name: the domain name of the peer Dynamic: the core SIP trunk works as a server, and you need to configure username, authentication ID and password for the SIP trunk, which will be used when a peer device tries to register to the core SIP trunk. If the peer device registers to the core SIP trunk successfully, the status of the SIP trunk will be 'True'. If the peer device fails to register or does not register to the SIP trunk, the status of the SIP trunk will be 'False'.
Advanced	
Bandwidth Limit	You can set the total amount of bandwidth in the box on the left, and choose a bandwidth limit profile on the right box. The bandwidth limit profile which illustrates what kind of packets will be limited need to be preset on the Service →Bandwidth page (3.4.18).
Signaling DSCP	The QoS tag of SIP signaling messages. It is 'BE' by default
Audio Media DSCP	The QoS tag of audio media messages. It is 'BE' by default

Video Media DSCP	The QoS tag of video media messages. It is 'BE' by default
Near-end NAT	Near-end NAT defaults to disabled. If it is enabled, the contact IP address contained in SIP messages sent out by SBC300 will be turned into the outbound IP address of public network. If NAT is enabled, you need to fill in the outbound IP address of public network.
Refresh Media Penetration	If this parameter is enabled and the user terminal on one side of the SBC300 refreshes media messages such as codec, the refresh will be penetrated to the user terminal on the other side of the SBC300
Respond to media refresh	If this parameter is enabled, the SBC300 will respond to the media refresh
Initial Invite Message carrying SDP	If this parameter is enabled, initial invite message will carry SDP by default
Domain Filter	
Rate Limit	The maximum RPS(registrations per second), CPS(calls per second) and total call volume. Please refer to 3.4.14
Blacklist	Select a blacklist for the access SIP trunk. Calls given by the caller numbers on the blacklist will be refused to go through the core SIP trunk. Please refer to 3.4.9
Whitelist	Select a whitelist for the access SIP trunk. Calls initiated by the caller numbers on the whitelist will be allowed to go through the core SIP trunk. Please refer to 3.4.9 If no black list and white list are selected for the core SIP trunk, all calls are allowed to go through the core SIP trunk
Inbound Manipulation	Select a number manipulation rule or a number pool for the core SIP trunk. When a call coming into the core SIP trunk matches the manipulation rule, its number will be manipulated. Please refer to 3.4.10 and 3.4.11
Inbound SIP Header Manipulation	Select a SIP header manipulation rule for inbound calls of the core SIP trunk. If a call matches the manipulation rule, the SIP header of the messages related to the call will be manipulated when it comes into the core SIP trunk. Please refer to 3.4.15
Outbound SIP Header Manipulation	Select a SIP header manipulation rule for outbound calls of the core SIP trunk. If a call matches the manipulation rule, the SIP header of the messages related to the call will be manipulated when it goes out the core SIP trunk Please refer to 3.4.15
SIP Account	Select a SIP account or a group of SIP accounts which will be bound (registered) to this core SIP trunk
Remote Server	The domain of the remote server where this core SIP trunk is registered

Domain	
Registration	If registration is enabled, the core SIP trunk will be registered to the configured remote server address and port, and the status of the core SIP trunk will become 'True'. Otherwise, the status is 'False'. For the status of core SIP trunk, please refer to 3.3.4 .
Username	The username used for registration; it's the same as configured in the remote server
Authentication ID	The authentication id used for registration; it's the same as configured in the remote server
Password	The password used for registration; it's the same as configured in the remote server
Registered Interval	The valid period of the registration, such as 1800s. It means you need to refresh the registration within 1800s.
Timeout coefficient	The parameter is used to determine when to refresh the registration. For example, if the 'Registered Interval' is 60s and the 'Timeout coefficient' is 1, the time to refresh the registration will be $60s * 0.8 * 1 = 48s$.
Keepalive	If 'Keepalive' is disabled, the SBC300 will not detect whether the core SIP trunk's remote device (generally it is the core network server) is reachable or not. If it is enabled, option message will be sent to detect the remote server in core network is reachable. If response is received, it means the remote server is reachable, and the status of the core SIP trunk is 'True'. Otherwise, the status will be 'False'. For the status of core SIP trunk, please refer to 3.3.3 .
SIP Session Timer	Session timer is a mechanism to keep activating sessions. If 'Supported' is selected, SBC300 will send 'reinvite' messages to keep activating sessions within the configured duration. If no messages are detected within the configured duration, sessions will be considered as 'ended', and then will be disconnected. If 'Require' is selected, the callee side of a call passing through the core SIP trunk also needs to support session timer.
Session Expire	Configure the duration of the session. During the duration, SBC300 will send 'reinvite' messages to keep activating the session.
Min. Session Timeout	Minimum session duration is used to negotiate with the session timer on the callee side
PRACK	PRACK (Provisional Response ACKnowledgement): provide reliable provisional response messages. Disable: INVITE request and 1xx response sent out by SBC300 will not include <i>100rel</i> tag by default; Support: INVITE request and 1xx response sent out by SBC300 will include <i>100rel</i> tag in Supported header; Require: INVITE request and 1xx response sent out by SBC300 will include <i>100rel</i> tag

	in Require header; if the peer does not support 100rel, it will automatically reject INVITE request with 420; if the peer supports 100rel. it will send <i>PRACK</i> request to acknowledge the response.
Peer Media Address	Lock: when the peer device works at public network, media address carried in SDP (Session Description Protocol) message is locked; when the peer device works at private network, the address that sends 30 messages continuously are locked. Unlock: remote address sending media messages is not locked.
Refresh Remote Media Address	If this parameter is enabled, the remote address receiving media messages will be refreshed.
Peer Signaling Address	Lock: when a calling account is successfully registered, the access SIP trunk only receives those calls from the registered address of the caller.
Caller From	User: the USER field of FROM header of INVITE message is extracted as caller number Display: the DISPLAY field of FROM header of INVITE message is extracted as caller number
Callee From	User: the USER field of TO header of INVITE message is extracted as callee number; Display: the DISPLAY field of TO header of INVITE message is extracted as callee number; Request-uri: the USER NUMBER in REQUEST-URI of INVITE message is extracted as callee number;
SIP Methods	Configure the SIP request methods that can be accepted by the core SIP trunk; If a SIP request method is not enabled, the system will reject the corresponding SIP request. By default, the INVITE request, REGISTER request and SESSION DISCONNECT request are accepted.

3.4.4 Routing Profile

(1) SIP Trunk Group

On the **Routing Profiles** → **SIP Trunk Group** interface, you can group several access SIP trunks or core SIP trunks, and then set a strategy (backup or load balance) for choosing which truck will be used under a trunk group when a call comes in.

The screenshot shows a web interface for configuring a SIP Trunk Group. The form is divided into two sections by a horizontal line. The top section contains:

- Name**: A text input field with a red asterisk indicating it is required.
- Description**: A text input field.
- Type**: A dropdown menu currently set to "Core SIP Trunk Group".
- Routing Mode**: A dropdown menu currently set to "Backup".

 The bottom section contains:

- SIP Trunk Name**: A dropdown menu showing "1<2>" and a "Delete" button.
- Capacity Allocation**: A text input field.

 At the bottom of the form are two green buttons: "Submit" and "Cancel".

Figure 3-23 Configure SIP Trunk Group

Table 3-15 SIP Trunk Group

Name	The name of the SIP trunk group. It cannot be modified after the SIP trunk group has been added successfully
Description	The description of the SIP trunk group
Trunk Type	If you just choose a sip trunk, it can be access SIP trunk or core SIP trunk. If you choose a trunk group, it can be access SIP trunk group or core SIP trunk group.
Routing Mode	The strategy for choosing which truck will be used under a trunk group when a call comes in. Backup : if the status of the first SIP trunk is 'True', the call will be always routed by the first SIP trunk. If the status of the first SIP trunk is 'False', the call will be routed by the next available SIP trunk. Load Balance : Trunk will be chosen according to the weight configured for it. For example, assuming the weight of a SIP trunk is 60% and that of the other SIP trunk in the same group is 40%, if there are 10 calls comes in, 6 calls will be routed by the first SIP trunk, and 4 calls will be routed by the second SIP trunk.
SIP Trunk Name	The name of the access SIP trunk or core SIP trunk included in the trunk group
Capacity Allocation	The allowed quantity of concurrent calls that are forwarded by the access SIP trunk or core SIP trunk

(2) Call Routing

On this page, you can configure routing for calls after you have configured a SIP trunk or a SIP trunk group. Routing profile involves the routing source and destination, manipulation rule and other parameters.

Priority *	1022
Description	21
Valid	<input checked="" type="checkbox"/>
dtmf Negotiate	<input checked="" type="checkbox"/>
Passthrough 183 response without sdp	<input checked="" type="checkbox"/>
Condition	
Number Profile	<input type="text"/>
Caller Username	<input type="text"/>
Callee Username	<input type="text"/>
Time Profile	<input type="text"/>
Caller SIP URL	<input type="text"/>
Callee SIP URL	<input type="text"/>
Source	Core SIP Trunk
	1<2>
SIP Methods	<input type="text"/>
Request URI	<input type="text"/>
Destination	
	Access Network
	1<1>
Outbound Manipulation	<input type="text"/>
SIP Header Passthrough	<input type="text"/>
request-uri Username	to inManipulation user
request-uri IP Addr.	remote address
to Username	to inManipulation user
to IP Addr.	remote address
to Username Displayed	to displav
from Username	from inManipulation user
from IP Addr.	local address
from Username Displayed	from displav
	<input type="button" value="Save"/> <input type="button" value="Cancel"/>

Figure 3-24 Call Routing

Table 3-16 Call Routing

Priority	The priority for a call to choose this route; the higher value, the lower priority.
Description	The description of the route, which is generally used to identify the route
Valid	If the checkbox on the right is selected, the route will be valid, otherwise it will be invalid
DTMF Negotiate	Whether to negotiate with DTMF modes (including SIP Info, INBAND, RFC2833)
Passthrough 183 Responsive without SDP	If the checkbox on the right is selected, 183 responsive messages without SDP will be passed through directly

Number Profile	The number profile set for matching the route. If the caller number or the called number of a call matches with a number in this profile, the call will be routed by the route. This parameter is optional to fill in. Make reference to 3.4.8 .
Caller Username	The caller number set for matching the route, which supports regular expression. If the caller number of a call matches with this number, the call will be routed by the route. If this parameter is null, it means caller number can be any number.
Callee Username	The callee number set for matching the route, which supports regular expression. If the callee number of a call matches with this number, the call will be routed by the route. If this parameter is null, it means callee number can be any number.
Time Profile	The profile of time during which the route can be used; If this parameter is null, it means the route can be used at any time. Please make reference to 3.4.9
Caller SIP URL	If the 'SIP URL' field of the 'FROM' header of a request message sent by a caller number matches with the value configured here, the call will be routed by the route. If this parameter is null, it means the SIP URL from caller can be any.
SIP URL	If the 'SIP URL' field of the 'FROM' header of a request message sent by a callee number matches with the value configured here, the call will be routed by the route. If this parameter is null, it means the SIP URL from callee can be any.
Source	The source of the call routed by the route. If the source of a call is access network or access SIP trunk, the destination can only be core SIP trunk; If the source of a call is core SIP trunk, the destination can be access network or access SIP trunk.
SIP Methods	The SIP method(s) supported by the route. If this parameter is null, it means SIP methods can be any.
Destination	The destination of the call routed by the route. If the destination of a call is access network or access SIP trunk, the source can only be core SIP trunk; If the destination of a call is core SIP trunk, the source can be access network or access SIP trunk.
Outbound Manipulation	If a number manipulation rule is set for the route, the caller number or called number of a call directed by the route will be manipulated. For manipulation rule, please make reference to 3.4.10
SIP Header Passthrough	If an SIP header passthrough rule is set for the route, the designated extension fields of SIP messages of this route will be passed through.

Note:

Caller number or called number can also be manipulated when a call comes into an access network, access SIP trunk or core SIP trunk. In this section, number is manipulated after a call has finished choosing a route.

3.4.5 Media Detection

On the **Service → Media Detection** page, you can choose to enable or disable ‘Use callid to match sessions’, ‘RTP Detection’ and ‘Disconnection’. If ‘RTP Detection’ is enabled, the SBC300 device will monitor the RTP packets of each call and will disconnect the call after it finds that no RTP packets are sent or received during the detection time.

Use callid to match sessions

RTP Detection

Disconnection

Interval s

Start Media Port

Report Time

Media anomaly statistics

Note: 1.The value for ‘Start Media Port’ should be an intergal multiple of 2K(K=1024).
2.The configuration of ‘Start Media Port’ will not take effect until the SBC device is rebooted.

Save

Figure 3-25 Media Detection

Table 3-17 Explanation of parameters for Media Detection

Use called to match sessions	If this parameter is enabled, the SBC300 device will match sessions with call ID, and if the call ID(s) are then same, it will judge that the sessions are belong to a same call.
RTP Detection	If this parameter is enabled, the SBC300 device will monitor the RTP packets of each call and detect whether there are RTP packets being sent or received.
Disconnection	If this parameter is enabled and no RTP packets are detected, the SBC will disconnect the call. If it is disabled, the call will not be disconnected, although no RTP packets are detected.
Interval	The time to determine when to disconnect the call after no RTP packets are detected. For example, if the ‘Interval’ is 300s, it means the call will be disconnected in 300 seconds after no RTP packets are detected.
Report Time	If ‘Media Anomaly Statistics’ is selected, ‘Report Time’ is the interval to report the statistics
Media Anomaly Statistics	Whether to report media anomaly statistics

3.4.6 CDR

On the **Service** → **CDR** page, the CDR server defaults to 'Disabled', and you need to enable it to do corresponding configurations.

Figure 3-26 Configure CDR Server

Table 3-18 Explanation of parameters for CDR

Local DB	If this parameter is selected, all the CDRs will be saved to the local database of the SBC300 device
Only abnormal CDRs can be saved locally	If this parameter is selected, only the abnormal CDRs will be saved to the local database of the SBC300 device
CDR Server	You need to enable the CDR server, otherwise all CDRs will not be recorded or saved
Name	The name of the CDR server. It cannot be modified after the CDR server has been successfully added
Description	The description of the CDR server
Interface	The interface through which the CDR server receives CDRs
Format	The coded format of CDRs, which supports syslog and json currently
IP Address	The IP address of the CDR server
Port	The SIP port through which the CDR server receives CDRs
Transport	The transport protocol adopted to transport CDRs, which can be UDP or TCP

3.4.7 Codec Profile

SBC300 supports such codecs as G729, G723, PCMU, PCMA, ILBC_13K, ILBC_15K, OPUS and AMR. You can group these codecs and adjust their priority according to your needs.

Codec Profile + Add

Name	Description	Codec	Max Packetizing Time
default	default	PCMA , PCMU , G723 , G729 , iLBC_15K , iLBC_13K , OPUS , AMR	60

Name * default

Description default

Max Packetizing Time * 60

Codec *

PCMA

>

PCMU
G723
G729
iLBC_15K
iLBC_13K
OPUS
AMR

<

Disable Enable

Payload 8

Packetizing Time 20

Video Media Forbidden

Penetrate MIME

Save
Cancel

Figure 3-27 Configure Codec Profile

Table 3-19 Explanation of Parameters for Codec Group

Name	The name of the codec group. It cannot be modified after the codec group has been added successfully
Description	The description of the codec group
Max. Packetizing Time	The maximum packetizing time that the codec group supports
Codec	SBC1000 supports codecs including PCMA, PCMU, G.729A/B, G.723, iLBC_13K, iLBC_15K, AMR and OPUS
Payload	The codec value of each codec, which cannot be modified
Packetizing Time	The default packetizing time of each codec, which cannot be modified
Video Media Forbidden	If this parameter is selected, video media will be forbidden
Penetrate MIME	Whether to penetrate MIME

Note:

There is a default codec group on the page. This codec group includes all the codecs by default. It can be modified but cannot be deleted.

3.4.8 Number Profile

On the **Service → Number Profile** page, you can set a prefix for calling numbers or called numbers. When the prefix of a calling number or a called number matches the set prefix, the call will be passed to choose a route. You can also import number profiles according to the format description on this page. The exported number profiles are in 'txt' format.

Number profile does not support 'Regular Expression' currently.

Click , and you can add a number profile.

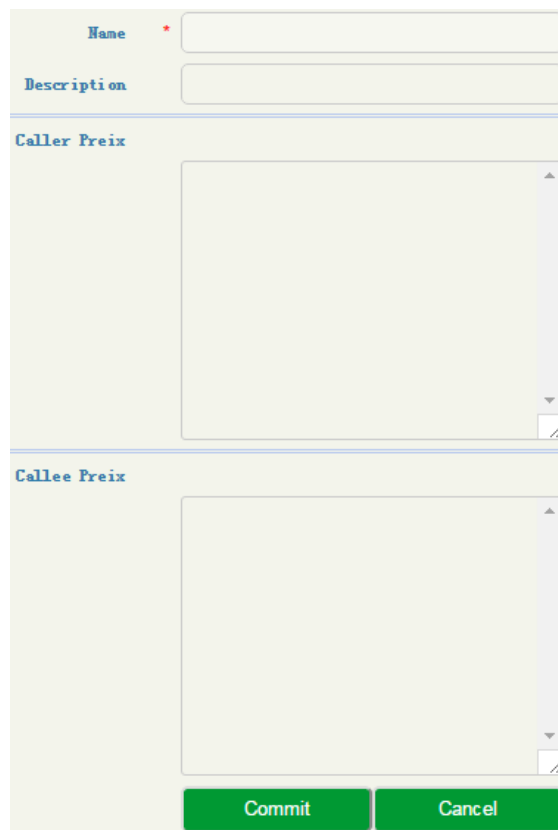

Figure 3-28 Add Number Profile

Table 3-20 Explanation of Parameters for Number Profile

Name	The name of the number profile. It cannot be modified after the number profile is added successfully
Description	The description of the number profile
Caller	The prefix set for caller numbers. It does not support regular expression.

Prefix	When the prefix of a caller number matches the set prefix, the call will be passed to choose a specific route.
Callee Prefix	The prefix set for callee numbers. It does not support regular expression. When the prefix of a callee number matches the set prefix, the call will be passed to choose a specific route.

3.4.9 Black & White List

On the **Service** → **Black & White List** page, you can choose to put calling numbers on a black list or white list. If a number is put on a black list and the black list is linked to an access network, an access SIP trunk or a core SIP trunk, the SBC1000 device will refuse the calls and registration requests from this number.

If a number is put on whitelist and the white list is adopted, the SBC1000 device will accept the calls and registration requests from this number.

You can also import numbers into a blacklist or whitelist according to the format description on this page. The imported or exported blacklists/whitelists are in 'txt' format.

Figure 3-29 Blacklist

Figure 3-30 Whitelist

Table 3-21 Blacklist & Whitelist

Blacklist Group	The name of the blacklist group. It cannot be modified after the blacklist group is added successfully
Whitelist Group	The name of the whitelist group. It cannot be modified after the whitelist group is added successfully
Description	The description of the blacklist/ whitelist group
Number	The calling number(s) that is (are) put on blacklist/ whitelist. It does not support regular expression.
Description	The description of a specific blacklist/ whitelist

3.4.10 Number Manipulation

Number manipulation refers to the change of a called number or a caller number during calling process when the called number or the caller number matches the preset manipulations rules.

Under a number manipulation profile, you can add multiple manipulation rules to change a caller number or a callee number.

Number Manipulation				+ Add
Name	Description	Caller Number	Callee Number	

The screenshot shows a web interface for configuring a Number Manipulation Rule. The form is organized into three main sections, each separated by a horizontal line. The first section is for the 'Caller Number' and includes fields for 'Name' (with a red asterisk), 'Description', 'Delete Prefix' (with a 'Delete' button), 'Delete Suffix', 'Add Prefix', 'Add Suffix', 'Condition', and 'Replacement'. The second section is for the 'Callee Number' and includes similar fields for 'Delete Prefix', 'Delete Suffix', 'Add Prefix', 'Add Suffix', 'Condition', and 'Replacement'. Below the second section is a '+ Add' button. At the bottom of the form, there is a checkbox labeled 'Synchronize the request-uri username' which is checked, and two large green buttons labeled 'Submit' and 'Cancel'.

Figure 3-31 Configure Number Manipulation Rule

Table 3-22 Explanations of Parameters for Number Manipulation Rule

Name	The name of this number manipulation profile. It cannot be modified after the manipulation rule has been added successfully
Description	The description of this number manipulation profile
Delete Prefix	The prefix that will be deleted after it matches a caller/callee number. For example, if the prefix is set as 678 and the caller number is 67890000, then the caller number will be changed into 9000; The prefix supports regular expression; Multiple prefixes can be set for one manipulation rule.
Delete Suffix	The suffix that will be deleted after it matches a caller/callee number. For example, if the suffix

	<p>is set as 123 and the caller number is 8000123, then the caller number will be changed into 8000;</p> <p>The suffix supports regular expression;</p> <p>Multiple suffixes can be set for one manipulation rule.</p>
Add Prefix	<p>The prefix added to the caller/callee number. For example, if the prefix is set as 678 and the caller number is 9000, then the caller number will be changed into 6789000 after the manipulation rule is matched;</p> <p>The prefix does not support regular expression;</p>
Add Suffix	<p>The suffix added to the caller/callee number For example, if the suffix is set as 678 and the caller number is 9000, then the caller number will be changed into 9000678 after the manipulation rule is matched;</p> <p>The suffix does not support regular expression;</p>
Condition	<p>The condition supports regular expression.</p> <p>If a caller/callee number can match one of the rules set in the 'Condition' parameter, the original number will be changed into the one set in the 'Replacement' parameter.</p>
Replacement	<p>If a caller/callee number can match one of the rules set in the 'Condition' parameter, the original number will be changed into the one set in the 'Replacement' parameter.</p> <p>The value of the 'Replacement' parameter does not support regular expression.</p>

Note:

During number manipulation, 'Delete Prefix' and 'Delete Suffix' are carried out first, followed by 'Add Prefix' and 'Add Suffix'. If 'Condition' is also set, SBC300 will match the condition based on the result of the abovementioned rules.

If a number manipulation profile is used on the **Service → Access Network** page, the **Service → Access SIP Trunk** page or the **Service → Core SIP Trunk** page, it means the caller/callee number will be manipulated before the call chooses a route;

If a number manipulation rule is used on the **Service → Routing Profile → Call Routing** page, it means the caller/callee number will be manipulated after the call has chosen a specific route.

3.4.11 Number Pool

On the **Service → Number Pool** page, you can set a number pool. If the number pool is used on the **Service → Routing Profile → Call Routing** page, the caller/callee number will be randomly replaced by a number from the pool.

Number Manipulation + Add			
Name	Description	Caller Number	Callee Number

Figure 3-32 Configure Number Pool

Table 3-23 Explanations of Parameters for Number Pool

Name	The name of this number pool. It cannot be modified after the number pool has been added successfully
Description	The description of this number pool
Caller/Callee Number	<p>Prefix: If the prefix here is matched with a caller/callee number, the caller/callee number will be randomly replaced by a number from the pool;</p> <p>Start Number: The starting number of the number pool</p> <p>End Number: The ending number of the number pool</p>
Synchronize the request-uri username	Whether to synchronize the request-url username

3.4.12 SIP Account

On the **Service → SIP Account** page, you can add SIP accounts. These SIP accounts are used for registration on the **Service → Access SIP Trunk** page or the **Service → Core SIP Trunk** page. Under an SIP account group, multiple SIP accounts can be added.

On the page, you can also export or import the existing SIP accounts in the format of txt or csv.

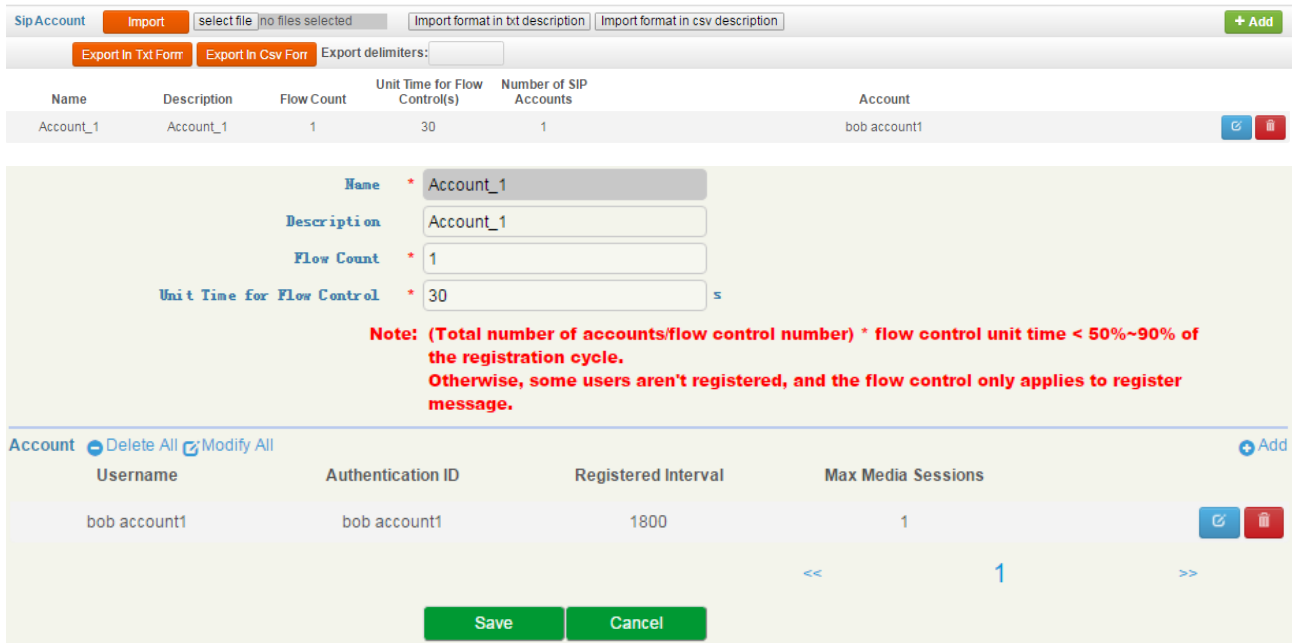

Figure 3-33 Configure SIP Account

Table 3-24 Explanations of Parameters for SIP Account

Name	The name of this SIP account group, under which multiple SIP accounts can be added. It cannot be modified after SIP account group has been added successfully.
Description	The description of this SIP account group, used to identify the SIP account group.
Flow Count	The number of registering messages allowed to be sent within the unit time
Unit Time for Flow Control	The unit time set for flow control. For example, if flow control is 1 and unit time is 30s, it means that only one registering message is allowed to be sent within 30 seconds.
Username	The username used for registration; it's the same as configured in the remote server
Authentication ID	The authentication id used for registration; it's the same as configured in the remote server
Registered Interval	The interval to initiate a registration by this SIP account. The actual registration interval needs to be negotiated between the SIP account and the remote server.
Max Media Sessions	The maximum concurrent calls that are allows by this SIP account.

3.4.13 Time Profile

On the **Service** → **Time Profile** page, you can set a time period for calls to choose routes. If the local time when a call is initiated falls into the set time period, the call will be passed to choose a corresponding route. If a call is initiated at other time, the call cannot be routed.

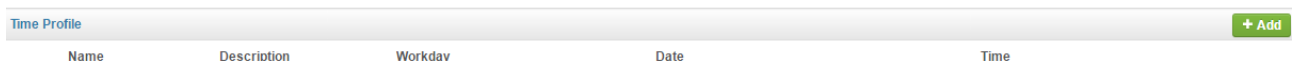

Click , and you can add a time profile.

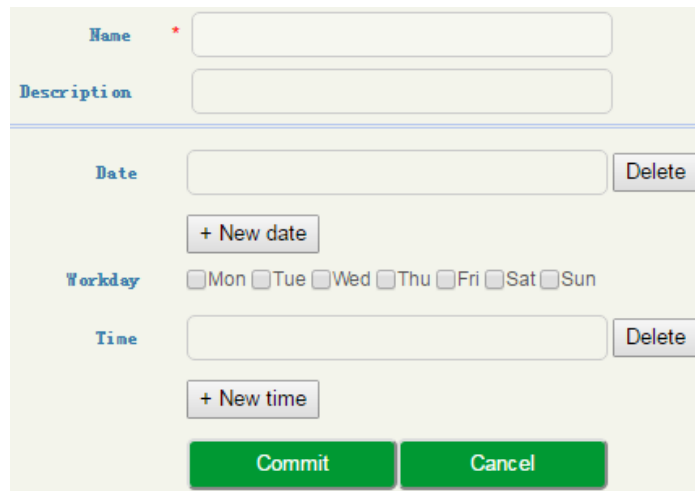

Figure 3-34 Add Time Profile

Table 3-25 Time Profile

Name	The name of the time profile. It cannot be modified after the time profile is added successfully
Description	The description of the time profile
Date	Configure the starting date and ending date of a period; You are allowed to configure multiple periods
Workday	Choose one or more working days (from Monday to Sunday)
Time	Choose the starting time and ending time of a day You are allowed to configure multiple time periods

3.4.14 Rate Limit

On the **Service** → **Rate Limit** page, you can configure the maximum registrations per second (RPS), maximum calls per second (CPS) and maximum concurrent calls for access network, access SIP trunk and core SIP trunk.



Name	Description	RPS	CPS	Max.Concurrent Calls
default	default	250	200	3000

Name	* default
Description	default
RPS	* 200
CPS	* 200
Max Media Sessions	* 3000

Save Cancel

Figure 3-35 Add Time Limit

Table 3-26 Rate Limit

Name	The name of the rate limit rule. It cannot be modified after the rate limit rule is added successfully
Description	The description of the rate limit rule
RPS	The maximum number of registrations that is allowed per second
CPS	The maximum number of calls that is allowed per second
Max. media sessions	The maximum number of concurrent calls that is allowed

Note:

- There is a default rate limit rule on the page. Its RPS, CPS and maximum number of concurrent calls are defined by License.
- The RPS, CPS and maximum concurrent calls configured in other rate limit rules cannot be greater than those of default rule.

3.4.15 SIP Header Manipulation

When the SIP headers of the messages related to calls passing through access network, access SIP trunk and core SIP trunk are not consistent with those required, you need to set rules to manipulate original SIP headers.

SIP Header Manipulation + Add				
Name	Description	SIP Header Type	Value Type	Routing Profiles
SunnyTest		request		rule001 ✎ 🗑

The screenshot shows the configuration page for a SIP Header Manipulation Rule. At the top, there are three input fields: 'Name' with the value 'rule001', 'Description' with the value 'sunnytan changed into dinstar002', and 'Type' set to 'RequestLine'. Below these is a 'Condition' section with a table containing one row: Source ID '\$from.\$displayname', Match 'equal', and Value 'sunnytan'. Underneath is an 'Operation' section with a table containing one row: Destination ID '\$request-line.\$uri', Action 'modify', Value 'dinstar002', Value Type 'value', Match '-', and Rule '-'. At the bottom of the form are two green buttons labeled 'Save' and 'Cancel'.

Figure 3-36 Configure SIP Header Manipulation Rule

Table 3-27 Explanations of Parameters for SIP Header Manipulation

Name	The name of the SIP header manipulation rule. It cannot be modified after the SIP header manipulation rule has been added successfully
Description	The description of the SIP header manipulation rule
SIP Header Type	Request: The manipulation rule is only applied to SIP request messages; Response: The manipulation rule is only applied to SIP response messages; List: The manipulation rule is only applied to those SIP request and response messages that are selected
Operation	<p>The operation rule will be applied when the set condition is met. For example, when the set value meets the source ID in Request Line, the actions (add, modify or remove) will be conducted on the destination ID.</p> <p>Name: the name of the operation rule.</p> <p>Description: the description of the operation rule.</p> <p>Type: the content type where the operation rule will be applied.</p> <p>Request-line: the content of the request line of SIP message.</p> <p>Status-line: the content of the status line of SIP message.</p> <p>Header: the content of the header of SIP message.</p> <p>Condition: the set condition for the operation rule. When the set value matches the source ID, the operation rule will be activated.</p> <p>Source ID: the original content of SIP message, it can be any parameter included in SIP message.</p> <p>Match: equal → when the source ID is equal to the set value, the operation rule is activate. Regex→ when the source ID matches the set regular expression, the operation rule will be</p>

	<p>activated.</p> <p>Value: the value set to match the source ID.</p> <p>Destination ID: the designated header to be modified.</p> <p>Action: The actions (add, modify or remove) to manipulate SIP header after the preset conditions is matched.</p> <p>Value Type: Token→ In the 'Value' field, the content with \$ is the content which is from the designated header of original SIP message.</p>
--	---

3.4.16 SIP Header Passthrough

On the **Service → SIP Header Passthrough** page, you can configure one or more 'SIP Header Passthrough' profiles. If the profiles are used on the **Service → Routing Profile → Call Routing** page, the designated extension fields of SIP messages of a specific route will be passed through.

SIP Header Pass
+ Add

Name	Description	SIP Header
<div style="background-color: #f0f0f0; padding: 10px; border: 1px solid #ccc;"> <div style="display: flex; flex-direction: column; gap: 10px;"> <div style="display: flex; justify-content: space-between;"> Name * <input style="width: 80%; border: 1px solid #ccc;" type="text"/> </div> <div style="display: flex; justify-content: space-between;"> Description <input style="width: 80%; border: 1px solid #ccc;" type="text"/> </div> <div style="border-top: 1px solid #0070c0; padding-top: 5px;"> SIP Header <div style="border: 1px solid #ccc; height: 150px; margin-top: 5px;"></div> </div> <div style="display: flex; justify-content: center; gap: 10px; margin-top: 10px;"> Commit Cancel </div> </div> </div>		

Figure 3-37 SIP Header Passthrough

Table 3-28 Explanations of Parameters for SIP Header Pass

Name	The name of the 'SIP header passthrough' profile. It cannot be modified after the 'SIP header pass' profile has been added successfully
Description	The description of the 'SIP header passthrough' profile
SIP Header	The SIP headers that are passed through.

	A SIP header in a row, case-sensitive, without any extra punctuation marks
--	--

Note:

1.The ‘Allow’ and ‘Supported’ SIP headers can only be passed through during registration. That is to say, they cannot be passed through during calling. Please think carefully before passing through these two SIP headers, as they might conflict with the configurations of SBC300.

2.The following SIP heads are not allowed to be passed through:

Network, To, From, Contact, Cseq, Max-Forwards, Content-Length, Content-Type, Via, Require, Proxy-Require, Unsupported, Authorization, Proxy-Authorization, Www-Authenticate, Proxy-Authenticate, Accept, Route, Record-Route, Refer-To, Referred-By, Auto-Defined.

3.4.17 Quality Monitoring

On the **Service** → **Quality Monitoring** page, you can set triggering conditions for the SBC device to monitor the packet loss rate, network jittering and delay time of current calls. That is to say, the quality of current calls will be monitored if they meet the preset triggering conditions.

Quality Monitoring												+ Add
Priority	Description	Source					Destination					Action
		Interface	Remote IP	Packet Loss Rate	Delay	Network Jitter	Interface	Remote IP	Packet Loss Rate	Delay	Network Jitter	

Priority *	<input type="text" value="127"/>
Description	<input type="text"/>
Call Duration	<input type="text"/> s
Trigger Rules (Source)	
Interface	<input type="text"/>
Remote IP	<input type="text"/>
Packet Loss Rate	<input type="text"/> %
Delay	<input type="text"/> ms
Network Jitter	<input type="text"/> %
RtpPackets Received	<input type="text"/>
RtpPackets Sent	<input type="text"/>
Trigger Rules (Destination)	
Interface	<input type="text"/>
Remote IP	<input type="text"/>
Packet Loss Rate	<input type="text"/> %
Delay	<input type="text"/> ms
Network Jitter	<input type="text"/> %
RtpPackets Received	<input type="text"/>
RtpPackets Sent	<input type="text"/>
Action	<input type="text" value="Drop"/>
<input type="button" value="Submit"/> <input type="button" value="Cancel"/>	

Figure 3-38 Quality Monitoring

Table 3-29 Explanations of Parameters for Quality Monitoring

Priority	The priority of the quality monitoring rule. The largest digit, the highest priority
Description	The description of the quality monitoring rule.
Call duration	If the duration of a current call is equal to or longer than the value here and meantime it meets the triggering rules, the call quality will be monitored.
Trigger Rules (Source)	
Interface	The interface of the SIP trunk connecting the caller and the SBC device. If this parameter is filled in, the quality of calls going through this interface will be monitored.
Remote IP	The IP address of the caller. If this parameter is filled in, the quality of calls from this

	IP address will be monitored.
Packet Loss Rate	If the packet loss rate of a current call from the caller to SBC is equal to or greater than the value here, the call quality will be monitored.
Delay	If the delay time of a current call from the caller to SBC is equal to or longer than the value here, the call quality will be monitored.
Network Jitter	If the network jittering rate of a current call from the caller to SBC is equal to or larger than the value here, the call quality will be monitored.
RTP Packets Received	If the number of RTP packets received by the SBC300 device is equal to or larger than the value here, the call quality will be monitored.
RTP Packets Sent	If the number of RTP packets sent by the SBC300 device is equal to or larger than the value here, the call quality will be monitored.
Trigger Rules (Destination)	
Interface	The interface of the SIP trunk connecting the SBC300 device and the callee. If this parameter is filled in, the quality of calls going through this interface will be monitored.
Remote IP	The IP address of the callee. If this parameter is filled in, the quality of calls going to this IP address will be monitored.
Packet Loss Rate	If the packet loss rate of a current call from SBC to callee is equal to or greater than the value here, the call quality will be monitored.
Delay	If the delay time of a current call from SBC to callee is equal to or longer than the value here, the call quality will be monitored.
Network Jitter	If the network jittering rate of a current call from SBC to callee is equal to or larger than the value here, the call quality will be monitored.
RTP Packets Received	If the number of RTP packets received by the SBC300 device is equal to or larger than the value here, the call quality will be monitored.
RTP Packets Sent	If the number of RTP packets sent by the SBC300 device is equal to or larger than the value here, the call quality will be monitored.
Action	<p>The action (including drop, log, warning) taken by the SBC device.</p> <p>If 'Drop' is selected, all the triggering rules above will not take effect.</p> <p>If 'Log' is selected, the quality of calls that trigger the rules will be monitored and recorded in logs in the Overview → Monitoring Status page.</p> <p>If 'Warning' is selected, warnings will be given and can be seen on the Maintenance → Warning page after the rules are triggered.</p>

Note: In case that you set multiple triggering rules, call quality won't be monitored unless all the triggering rules are satisfied.

3.4.18 Bandwidth Limit

On the **Service** → **Bandwidth** Limit page, you can set the bandwidth reserved for each codec. Generally, there is a default value for each codec and you do not need to change it.

Name *	<input type="text"/>
Description	<input type="text"/>
Audio	
PCMU:	<input type="text" value="90.4"/> kbps
PCMA:	<input type="text" value="90.4"/> kbps
G723:	<input type="text" value="23.9"/> kbps
G729:	<input type="text" value="34.4"/> kbps
OPUS:	<input type="text" value="12"/> kbps
AMR:	<input type="text" value="12.2"/> kbps
ILBC_13K:	<input type="text" value="13.3"/> kbps
ILBC_15K:	<input type="text" value="15.2"/> kbps
Video	
VP8:	<input type="text" value="0"/> kbps
VP9:	<input type="text" value="0"/> kbps
H.263:	<input type="text" value="0"/> kbps
H.264:	<input type="text" value="0"/> kbps
H.265:	<input type="text" value="0"/> kbps
Note: Under the bandwidth limit strategy, each voice call is pre-allocated with 200 kbps and each video call is pre-allocated with 2 mbps.	
<input type="button" value="Submit"/> <input type="button" value="Cancel"/>	

Figure 3-39 Bandwidth Limit

3.5 Security

In the **Security** section, you can configure the system security strategies, access control strategies and anti-attack strategies. You can also set Tacacs authentication parameters on this page.

3.5.1 System Security

System security is mainly used to prevent SBC300 from being attacked by various DOS/DDOS floods, so as to ensure stable running of the device.

System Security		
Attack Log	<input type="checkbox"/>	
ICMP-Flood	<input checked="" type="checkbox"/>	Peak PPS(Packet Per Second) 50
TCP-NULL	<input checked="" type="checkbox"/>	
TCP XMAS TREE	<input checked="" type="checkbox"/>	
TCP-Flood	<input checked="" type="checkbox"/>	Peak PPS(Packet Per Second) 50
<input type="button" value="Save"/>		

Figure 3-40 System Security

Table 3-30 Explanation of Parameters for System Security

Attack Log	If 'Attack Log' is enabled and SBC300 is attacked, the device will record the attack in logs which can be viewed on the Maintenance →Log →Security Log page.
ICMP-Flood	ICMP-Flood is a kind of DDOS attack. It can send a mass of ICMP packets to attack the SBC300 device. If this parameter is enabled, the device will drop those packets whose transmission rate exceeds the configured value of peak PPS(Packet Per Second); the range of the peak PPS is from 1 to 1000.
TCP-NULL	TCP NULL is a scan to determine if ports are closed on the target device. If this parameter is enabled, SBC300 will drop TCP packages, and the peer device cannot learn whether the ports of SBC300 are closed or not.
TCP XMAS TREE	TCP XMAS TREE can send TCP packets with special tag to detect which ports are open on the target device. If this parameter is enabled, SBC300 will drop thoseTCP packages, and the peer device cannot learn which ports of SBC300 are open.
TCP-Flood	TCP-Flood is a kind of DDOS attack. It can send a mass of TCP requests to occupy the system resources of the target device and then to make the target device crash. If this parameter is enabled, the device will drop those packets whose transmission rate exceeds the configured value of peak PPS (Packet Per Second); the range of the peak PPS is from 1 to 1000.

3.5.2 Access Control

On the **Security →Access Control** page, you can configure the access ports (GE0, GE1, GE2 and GE3) for Web Server, SSH, Ping IPV4, SNMP as well as BFD (Bidirectional Forwarding Detection).

Web Server	
HTTPS Port	<input type="text" value="443"/>
HTTP Port	<input type="text" value="80"/>
Allowed to access GE0	<input checked="" type="checkbox"/>
Allowed to access GE1	<input checked="" type="checkbox"/>
Allowed to access GE2	<input checked="" type="checkbox"/>
Allowed to access GE3	<input checked="" type="checkbox"/>
SSH	
Port	<input type="text" value="22"/>
Allowed to access GE0	<input checked="" type="checkbox"/>
Allowed to access GE1	<input checked="" type="checkbox"/>
Allowed to access GE2	<input checked="" type="checkbox"/>
Allowed to access GE3	<input checked="" type="checkbox"/>
Ping IPV4	
Allowed to access GE0	<input checked="" type="checkbox"/>
Allowed to access GE1	<input checked="" type="checkbox"/>
Allowed to access GE2	<input checked="" type="checkbox"/>
Allowed to access GE3	<input checked="" type="checkbox"/>
SNMP	
Allowed to access GE0	<input type="checkbox"/>
Allowed to access GE1	<input type="checkbox"/>
Allowed to access GE2	<input type="checkbox"/>
Allowed to access GE3	<input type="checkbox"/>
BFD	
Allowed to access GE0	<input type="checkbox"/>
Allowed to access GE1	<input type="checkbox"/>
Allowed to access GE2	<input type="checkbox"/>
Allowed to access GE3	<input type="checkbox"/>
<input type="button" value="Save"/>	

Figure 3-41 Access Control

Table 3-31 Explanation of Parameters for Access Control

Web Server	The Web interface of SBC300 supports http and https. The http port defaults to 80, while the https port defaults to 443. You can modify the http/https port;
------------	--

	If you select the checkbox on the right of GE0, GE1, GE2 or GE3, it means the selected port.is allowed to access the Web interface of SBC300.
SSH	The SSH port of SBC300 defaults to 22. If you select the checkbox on the right of GE0, GE1, GE2 or GE3, it means the selected port.is allowed to access the SSH of SBC300.

3.5.3 Security Policy

(1) IP Security Strategy

Figure 3-42 IP Security Strategy

Click to add a strategy to prevent attacks from other IP addresses. Click to delete a strategy, while click to modify the strategy.

Figure 3-43 Add IP Security Strategy

Table 3-32 Explanation of Parameters for IP Security Strategy

Time Limiting	The validity time of the IP security strategy. When the validity time expires, the strategy needs to be retrIGGERED, otherwise it will not takes effect.
Index	The greater digit, the lower priority
Description	The description of the IP security strategy. It cannot be modified after the strategy has been successfully added.
Detection	Remote IP: when the packet traffic sent by remote IP exceeds the configured traffic threshold (KBPS) or the CPU usage exceeds the configured threshold, SBC300 will execute the preset

	<p>action.</p> <p>Local port: when the packet traffic received by local port exceeds the configured traffic threshold (KBPS) or the CPU usage exceeds the configured threshold, SBC300 will execute the preset action.</p>
CPU Usage	<p>The CPU usage rate</p> <p>If this parameter is null, it means CPU usage is not a condition for triggering security strategy.</p>
Traffic (KBPS)	<p>The maximum packet traffic sent by the peer IP or received by local port. If this threshold is surpassed, SBC300 will execute the configured action on the packets.</p>
Action	<p>Log Record: when the security strategy is triggered and takes effect, the attack event is recorded in a log</p> <p>Flow Limited: when the security strategy is triggered and takes effect, the traffic of peer IP address or the set local port is limited, and those packets whose traffics exceed are dropped during the limitation time.</p> <p>Packet Rate Limited: when the security strategy is triggered and takes effect, the packet rate of peer IP address or the set local port is limited, and those packets whose traffics exceed are dropped during the limitation time.</p> <p>Drop: when the security strategy is triggered and takes effect, all the packets from peer IP address and those received by the set local port are dropped during the limitation time.</p>

(2) SIP Security

Interval

Registration Interval s

Call Detention Interval s

SIP Security

Priority	Description	Attacked	Detected	Action	Protected Time	
124	detect register counts per ip	IP Anti Attacking	Number Of Registrations/30	Log Record	-	<input type="button" value="ⓘ"/> <input type="button" value="✖"/>
125	detect call counts per ip	IP Anti Attacking	Number Of Calls/10	Log Record	-	<input type="button" value="ⓘ"/> <input type="button" value="✖"/>
126	detect register counts per user	User Attack	Number Of Registrations/5	Log Record	-	<input type="button" value="ⓘ"/> <input type="button" value="✖"/>
127	detect call counts per user	User Attack	Number Of Calls/5	Log Record	-	<input type="button" value="ⓘ"/> <input type="button" value="✖"/>

Figure 3-44 SIP Security Strategy

Click to add a strategy to prevent attacks from SIP-based devices. Click to delete a strategy, while click to modify the strategy.

Priority *	124
Description	detect register counts per ip
Attacked	IP Anti Attacking
Detected	Number Of Registrations
*	30
Action	Log Record

Save Cancel

Figure 3-45 Add SIP Security Strategy

3.5.4 Tacacs Authentication Configuration

web login authentication method	<input checked="" type="checkbox"/> local authentication(default) <input type="checkbox"/> tacacs+ authentication
tacacs+ service configuration	
protocol type	IPV4
server IP	
server port	
local port	
Local Interface	GEO
shared key	
support single connection multi-session	<input type="checkbox"/>
verification timeout	5000 ms
verification protocol	AuthenTypeASCII

Save

Figure 3-46 Tacacs Authentication Configuration

3.6 System

On the System section, you can configure the device name, network, port mapping, static routes, username & password as well as time zone & current time. You can also upgrade software versions, backup or restore configuration data, and update license and certificate.

3.6.1 System Management

On the **System** → **System Management** page, you can configure the name of the SBC300 device.

The screenshot shows a web interface for System Management. At the top, there is a header 'System Management'. Below it, there is a label 'Device Name' followed by a text input field containing 'SBC300'. To the right of the input field is a green 'Save' button.

Figure 3-47 Modify Device Name

3.6.2 Web Configuration

On this page, you can set a time for the web's auto logout. That is to say, when the time configured here expires, the SBC300 device will automatically log out. The time is counted based on the login time of the device and the maximum time for logout is 480 minutes. Generally, if you are carrying out operations on the web, the device will not log out, although the time set for logout has expired.

The screenshot shows a web interface for Web Configuration. At the top, there is a header 'Web Configuration'. Below it, there are three configuration fields: 'Certification' with a dropdown menu set to 'default', 'Key' with a dropdown menu set to 'default', and 'Auto Exit Time' with a text input field set to '480' and a 'min' label. Below these fields is a green 'Save' button.

Figure 3-48 Web Configuration

3.6.3 Network

On the **System** → **Network** page, you can configure the IP address, Subnet mask, gateway and DNS server for each port. The SBC300 supports IPV4 and IPV6 at the same time.

The screenshot shows a web interface for Network configuration. At the top, there is a header 'Network' and a green '+ Add' button. Below it is a table with the following columns: Name, Service or Management Port, MTU, Mac, IPV4 Address, Subnet Mask, IPV4 Gateway, IPV4 DNS, IPV6 Address, IPV6 Gateway, IPV6 DNS, Priority, and an edit icon. The table contains five rows of data.

Name	Service or Management Port	MTU	Mac	IPV4 Address	Subnet Mask	IPV4 Gateway	IPV4 DNS	IPV6 Address	IPV6 Gateway	IPV6 DNS	Priority	
GE0	Service Port	1500	f8:a0:3d:40:77:20	172.21.180.31	255.255.0.0	172.21.1.1	8.8.8.8/114.114.114.114				20	
GE1	Service Port	1500	f8:a0:3d:40:77:21	192.168.13.1	255.255.255.0		/				30	
GE2	Service Port	1500	f8:a0:3d:40:77:22	192.168.14.1	255.255.255.0		/				40	
GE3	Service Port	1500	f8:a0:3d:40:77:23	192.168.15.1	255.255.255.0		/				50	
Admin	Management Port	1500	f8:a0:3d:40:77:24	172.21.180.30	255.255.0.0	172.21.1.1	8.8.8.8/114.114.114.114	2018:21::28/64			10	

Figure 3-49 Network Port

click  to modify the information of each network port.



The screenshot shows a web form for configuring a network port. The form is organized into three main sections: General, IPv4, and IPv6. Each section contains several labeled input fields. The General section includes Name, Mac, MTU, Priority, and Service or Management Port. The IPv4 section includes IPv4 Network Mode, IPv4 Address, Subnet Mask, IPv4 Gateway, and IPv4 DNS. The IPv6 section includes IPv6 Network Mode, IPv6 Address, IPv6 Gateway, and IPv6 DNS. At the bottom of the form are two green buttons labeled 'Save' and 'Cancel'.

Figure 3-50 Modify Network Port Information

Table 3-33 Explanation of Parameters for Network Configuration

Name	The name of the network port, including Admin, GE0, GE1, GE2 and GE3
Mac	The Mac address of the network port
MTU	The MTU (Maximum Transmission Unit) of the network port
Priority	When SBC300 visits an IP address of other network segment and this peer IP address is not directed by static route, SBC300 will go out from the network port or VLAN with the highest priority. The smaller digit, the higher priority.
Service or Management Port	The network is working as service port or management port
IPv4/IPv6 Network Mode	The way for network port (Admin, GE0, GE1, GE2 and GE3) to get its IP address. Currently, SBC300 only supports static IP address.
IPv4/IPv6 Address	The IP address of network port
Subnet Mask	The subnet mask of network port
IPv4/IPv6 Gateway	The gateway of network port
IPv4/IPv6 DNS	The address of DNS server for network port. You can fill in the address of primary and

Server	secondary DNS servers.
--------	------------------------

Click  to add a VLAN, while click  to delete a VLAN.

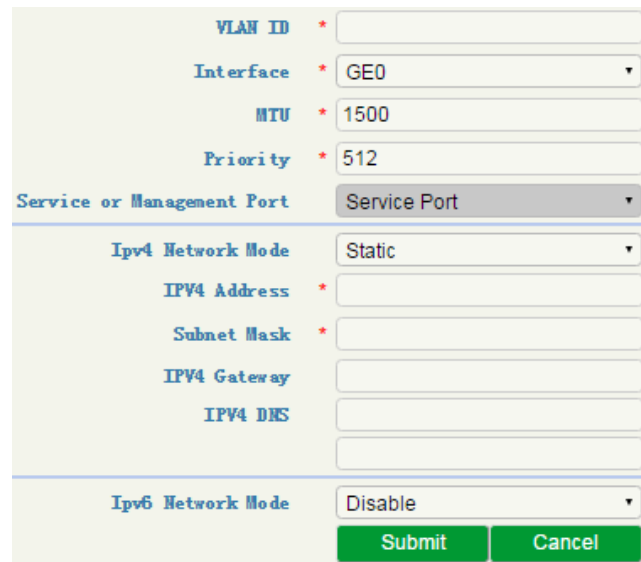

Figure 3-51 Add VLAN

Table 3-34 Explanation of Parameters for VLAN

VLAN ID	The ID of the added VLAN
Interface	Network port: Admin, GE0, GE1, GE2 and GE3
MTU	The MTU (Maximum Transmission Unit) of the network port
Priority	When SBC300 visits an IP address of other network segment and this peer IP address is not directed by static route, SBC300 will go out from the VLAN with the highest priority. The smaller digit, the higher priority.
Service or Management Port	The port of this VLAN is working as service port or management port
Network Mode	The way for the port (Admin, GE0, GE1, GE2 and GE3) to get its IP address. Currently, SBC300 only supports static IP address.
IPv4/IPv6 address	The IP address of the VLAN
Subnet Mask	The subnet mask of the VLAN
IPv4/IPv6 Gateway	The gateway of the VLAN
IPv4/IPv6 DNS	The address of DNS server for the VLAN. You can fill in the address of primary and secondary DNS servers.

3.6.4 Port Mapping

To ensure the security of the LAN (local-area network), SBC300 will reject the connection request from the wide-area network (WAN). Port mapping allows a client in the wide-area network to visit the SBC300 device in the local-area network.

The screenshot displays the 'Port Mapping' configuration page. At the top, there is a header bar with the title 'Port Mapping' and an '+ Add' button. Below this is a table with the following columns: Name, Status, Local Interface, Local IP, Local Port, Transport, Remote Interface, Remote IP, and Remote Port. The main content area shows a form for adding a new port mapping. The form fields are: Name (Port_mapping_1), Status (Valid), IPv4/IPv6 (IPV4), Transport (TCP), Local Interface (GE0), Local Port (5060), Remote Interface (GE0), Remote IP (172.16.0.2), and Remote Port (5080). There are Submit and Cancel buttons at the bottom of the form.

Figure 3-52 Configure Port Mapping

Table 3-35 Explanation of Parameters for Port Mapping

Name	The name of this port mapping
Status	To enable or disable
IPV4/IPV6	The network type of the SBC 300 in local-area network
Transport	Choose TCP, UDP or TCP\UDP
Local Interface	The local interface of SBC300. Choose GE0, GE1, GE2 or GE3
Local Port	The mapped port of the SBC300 device in local-area network (this port cannot conflict with the in-use port of the SBC300 device)
Remote Interface	The interface of the client in the wide-area network, which is to visit the SBC300 device in local-area network
Remote IP	The IP address of the client in the wide-area network, which is to visit the SBC300 device in the local-area network.
Remote Port	The port of the client in the wide-area network, which is to visit the SBC300 device in local-area network

3.6.5 Static Route

On the **System** → **Static Route** interface, you can configure static routes for the network. After a static route is successfully set, related packets will be sent to the designated destination according to the static route. Click

 to enter into the setting page of static route.



The screenshot shows a configuration form for adding a static route. The fields are as follows:

- Priority**: 127
- Description**: (empty)
- IPv4/IPv6**: IPV4
- Destination IP/Domain**: (empty)
- Subnet Mask**: (empty)
- Interface**: GE0
- Next Hop**: (empty)

At the bottom of the form are two buttons: **Submit** and **Cancel**.

Figure 3-53 Add Static Route

Table 3-36 Explanation of Parameters for Static Route

Priority	The priority of the static route. The smaller digit, the higher priority
Description	The description of the static route, used to identify the static route
IPv4/IPv6	The network type (IPv4 or IPv6) under which this static route is used
Destination IP/Domain	The destination IP address of the static route
Mask	The netmask of the static route, such as 255.255.255.0
Interface	The source interface of the static route, such as GE0, GE1, GE2 and GE3
Next Hop	The next hop address, namely the router address passed by the packets before they reach the destination address

3.6.6 User Manager

On the **System** → **User Manager** → **Password** page, you can modify administrator's password for logging in the SBC300 device. Factory defaults for administrator's username and password are 'admin' and 'admin@123#' which are also used to log in SSH.

Password

Password

Old Password

New Password

Password Strength

Confirm

Figure 3-54 Modify Password

User List

On the **System** → **User Manager** → **User List** page, the administrator can add the users that are allowed to log in the Web interface, specify their roles and allocate permissions to them.

Username * lich

Password *

Password Strength

Confirm *

Role * Admin

Permission

Overview	<input checked="" type="checkbox"/> View	
System Status	<input checked="" type="checkbox"/> View	
Access Network Status	<input checked="" type="checkbox"/> View	
Access Trunk Status	<input checked="" type="checkbox"/> View	
Core Trunk Status	<input checked="" type="checkbox"/> View	
Calls Status	<input checked="" type="checkbox"/> View	
Register Status	<input checked="" type="checkbox"/> View	
Attack List	<input checked="" type="checkbox"/> View	
Service	<input checked="" type="checkbox"/> View	<input checked="" type="checkbox"/> Edit
Media Detection	<input checked="" type="checkbox"/> View	<input checked="" type="checkbox"/> Edit
CDR	<input checked="" type="checkbox"/> View	<input checked="" type="checkbox"/> Edit
Number Profile	<input checked="" type="checkbox"/> View	<input checked="" type="checkbox"/> Edit
Time Profile	<input checked="" type="checkbox"/> View	<input checked="" type="checkbox"/> Edit
Rate Limit	<input checked="" type="checkbox"/> View	<input checked="" type="checkbox"/> Edit

Figure 3-55 Add User and Assign Permissions

Table 3-37 User List

Username	The name of the user, which is used to log in the SBC300 device
----------	---

Password	The password for the user to log in the SBC300 device
Confirm	Confirm the password
Password Strength	The security strength of the password
Role	Admin: has the permission to add users whose role is operator or observer, to modify the passwords of users, to add/delete/modify configurations. Only one administrator is allowed for one SBC300 device. Operator: has the permission to view configurations, or modify part of the configurations. Observer: has the permission to view existing configurations, but cannot delete or modify them.

3.6.7 Date & Time

On the **System** → **Date & Time** page, you can set a new time zone, synchronize local time and add NTP server.

Figure 3-56 Configure Date & Time

Table 3-38 Date & Time

Time Zone	Choose a time zone for the SBC300 device according to the location where the device is placed.
Synchronize Time	If the current time of SBC300 is wrong and the device fails to synchronize with a NTP server, you can synchronize the current time to that of the PC which is used to log in the web of the SBC300.
NTP Server	If NTP server is enabled, the time of SBC300 will be synchronize to that of NTP server.

3.6.8 Upgrade

On the **System** → **Upgrade** interface, you can upgrade the SBC300 to a new version. But you need to restart the device for the change to take effect after executing upgrade.

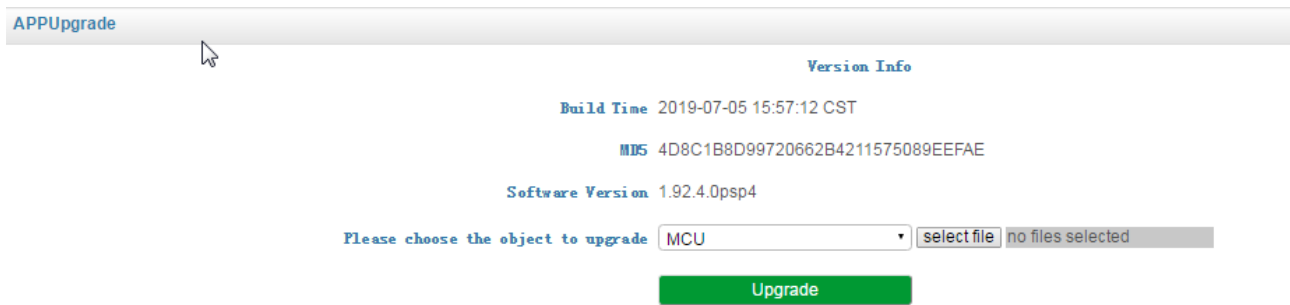

Figure 3-57 Software Upgrade

The version file used for upgrade is generally named as '1.91.x.x.ldf'. Please do not use other products' version files to upgrade the SBC300 device.

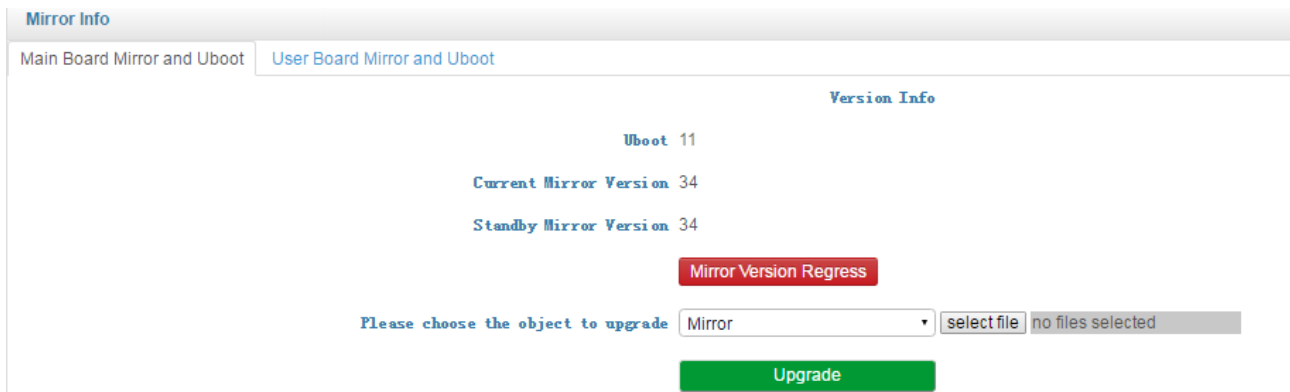

Figure 3-58 Mirror Upgrade

3.6.9 Backup & Restore

On the **System** → **Backup & Restore** interface, you can back up or restore all the configuration data, including service configurations, network configurations and license & certificate. After the configuration data is restored, the SBC300 device will automatically restart.

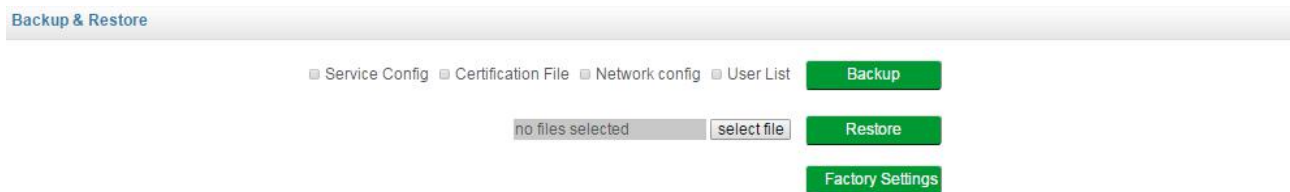

Figure 3-59 Backup & Restore

Table 3-39 Backup & Restore

Backup	You can download the configuration data as a backup. Select any of the checkboxes on the right of Service Config, Certification File, Network Config and User List, and then click Backup
Restore	Choose a backup file, and then click Restore .

Factory Settings	Click Factory Settings , and the configurations of the SBC300 device will become factory settings.
------------------	---

3.6.10 Double-device Hot Standby

Two SBC300 devices can be connected with each other through the 'Admin' port for the sake of hot standby. That is to say, the two SBC300 devices work in the active-standby mode. When the active device fails, it changes to the standby state while the standby device changes to the active state and take over the functionality of the failed device. In this way, services such as calling and transcoding, provided by SBC300, will not be interrupted in case that one of the SBC300 devices malfunctions.

3.6.11 License

On the **System** → **License** page, the license information, including license beginning time, license expiry time, maximum media sessions, maximum transcoded sessions, maximum registered users, RPS (registrations per second) and CPS(calls per second), is displayed. The SBC300 device will not accept registrations and calls after the license expires.

License	
Device SN	7
Device SN	dc28-0509-4004-0079
Hardware SN	2481-175A-282B
License Type	official
License Begin Time	2018-09-25 11:02:29.3260133 +0800 +0800
License Total Time	Permanent
License Expires	Permanent
Max Media Sessions	300
Max Transcoding Sessions	120
Max Registered Users	3000
RPS	20
CPS	20
Active And Standby	Single-device Cold Standby

Please input your license

Submit
Clear

Figure 3-60 License Information

3.6.12 Certificate

On the **System** → **Certificate** page, you need to upload a certificate to ensure the secure login to the Web interface of the SBC300 device. You cannot log in the device until you has uploaded a certificate.

Figure 3-61 Upload Certificate

3.7 Maintenance

3.7.1 Log

(1) Login Log

The logs tracing the logins of the SBC300 device can be viewed on the **Maintenance → Login Log** page. You are allowed to set query criteria to view the logs that you want.

Login Log							
10	Search: Name	Type	Begin Time	End Time	Source	Submit	
Index	Username	Role	Time	Login IP	Source	Description	
1	admin123	admin	2019-07-19 02:04:26	172.19.120.143:50840	web	Login success	
2	admin	admin	2019-07-18 07:20:40	172.21.180.16:51626	web	Login success	
3	admin	admin	2019-07-18 07:20:29	172.21.180.16:51626	web	CAPTCHA FAILED	
4	admin	admin	2019-07-18 07:03:56	172.21.180.16:51298	web	Login success	
5	admin	admin	2019-07-18 06:34:25	172.21.180.16:51263	web	Login success	
6	admin123	admin	2019-07-18 02:30:04	172.19.120.143:50407	web	Login success	
7	admin123	admin	2019-07-18 02:29:50	172.19.120.143:50407	web	Login failed	
8	admin123	admin	2019-07-18 02:27:34	172.19.120.143:50407	web	EXIT	
9	admin123	admin	2019-07-18 01:47:51	172.19.120.143:50407	web	Login success	
10	admin	admin	2019-07-17 05:49:08	172.21.180.16:55631	web	Login success	

Figure 3-62 Login Log

(2) Operation Log

The logs tracing the operations carried out on the Web interface can be queried on the **Maintenance → Operation Log** page. You are allowed to set query criteria to view the logs that you want.

Operational Log							
10	Search: Name	Type	Begin Time	End Time	Source	Submit	
Index	Username	Role	Time	Login IP	Source	Operation	Content
1	admin	admin	2019-07-18 07:22:03	172.21.180.16:51626	web	Apply	Sip Account
2	admin	admin	2019-07-18 07:22:02	172.21.180.16:51626	web	Mod.	Sip Account/Account_1
3	admin	admin	2019-07-18 07:09:13	172.21.180.16:51626	web	Apply	Core SIP Trunk
4	admin	admin	2019-07-18 07:09:12	172.21.180.16:51626	web	Mod.	Core SIP Trunk2
5	admin	admin	2019-07-18 07:04:21	172.21.180.16:51298	web	Apply	Core SIP Trunk
6	admin	admin	2019-07-18 07:04:17	172.21.180.16:51298	web	Mod.	Core SIP Trunk2
7	admin123	admin	2019-07-16 02:10:05	172.19.120.143:51830	web	Apply	Sip Account
8	admin123	admin	2019-07-16 02:10:05	172.19.120.143:51830	web	Apply	Core SIP Trunk
9	admin123	admin	2019-07-16 02:09:35	172.19.120.143:51808	web	Save	Core SIP Trunk
10	admin123	admin	2019-07-16 02:09:35	172.19.120.143:51808	web	Save	Sip Account

Figure 3-63 Operation Log

(3) Security Log

The logs related to security can be viewed on the **Maintenance → Security Log** page. You are allowed to set query criteria to view the logs that you want.

Security Log								
10	Search: Begin Time	End Time	Type	Source	IP Address	Interface	Port	Submit
Index	Time	Attacked	Source	IP Address	Interface	Port	Condition	Action
1	2019-07-15 08:24:57	IP	DDOS	172.21.180.16	eth90	0	Policy: default_ip, Host TX Rate: 2123KBPS	LOG
2	2019-07-15 08:24:57	PORT	DDOS		eth90	443	Policy: default_port, Host TX Rate: 2123KBPS	LOG
3	2019-07-15 08:24:47	IP	DDOS	172.21.180.16	eth90	0	Policy: default_ip, Host TX Rate: 5586KBPS	LOG
4	2019-07-15 08:24:47	PORT	DDOS		eth90	443	Policy: default_port, Host TX Rate: 5586KBPS	LOG
5	2019-07-15 08:24:42	IP	DDOS	172.21.180.16	eth90	0	Policy: default_ip, Host TX Rate: 2178KBPS	LOG
6	2019-07-15 08:24:42	PORT	DDOS		eth90	443	Policy: default_port, Host TX Rate: 2178KBPS	LOG
7	2019-07-10 10:21:35	IP	DDOS	172.21.180.16	eth90	0	Policy: default_ip, Host TX Rate: 2073KBPS	LOG

Figure 3-64 System Log

(4) Log Management

On the **Maintenance → Log Management** page, you can set the log level to filter logs, and can export the logs of different level.

Log Management	
Log Record	
Level	Warning
Time	5 min
Start	
Log Export	
Export	

Figure 3-65 Log Management

(5) Log Server

On this page, if you fill in an IP address of a designated log server, the syslogs of the selected level, received by the SBC300 device, will be sent to this log server.

Figure 3-66 Log Server

Table 3-40 Explanation of Parameters for Log Server

Level	<p>Disable: No syslog will be sent to this log server;</p> <p>Emerg: the syslogs in the level of emergence will be sent to this log server;</p> <p>Alert: the syslogs in the levels of alert and emergence will be sent to this log server;</p> <p>Crit: the syslogs in the levels of critical, alert and emergence will be sent to this log server;</p> <p>Err: the syslogs in the levels of error, critical, alert and emergence will be sent to this log server;</p> <p>Warning: the syslogs in the levels of warning, error, critical , alert and emergence will be sent to this log server;</p> <p>Notice: the syslogs in the levels of notice, warning, error, critical , alert and emergence will be sent to this log server;</p> <p>Info: the syslogs in the levels of information, notice, warning, error, critical , alert and emergence will be sent to this log server;</p> <p>Debug: the syslogs in all levels will be sent to this log server.</p>
IPv4/IPv6	The network type (IPv4 or IPv6) under which the log server works
Server Address	The IP address of the log server which will receive the syslogs from the SBC 300 device
Port	The SIP port of the log server
Transport	The transport protocol that the log server supports. You can choose UDP or TCP.

3.7.2 Reset

On the **Maintenance** → **Reset** page, you can reset the MFU, the MCU or the whole SBC300 device.

The choose of the MFU to be reset. : MFU0

Reset MFU

Reset MCU

Reset The Machine

Figure 3-67 Reset MFU, MCU or SBC Device

3.7.3 Ping

Ping is used to examine whether a network works normally through sending test packets and calculating response time.

Instructions for using Ping:

1. Select the network port of SBC300 and its network type (IPv4 or IPv6), enter the IP address of a network, a website or a device in the input box of 'Destination IP', and then click **Start**.
2. If related messages are received, it means the network works normally; otherwise, the network is not connected or is connected faultily.

Interface: GE0

IPv4/IPv6: IPV4

Destination IP: 172.16.0.2

Times (1-100): 4

Packet Size (56-1024): 56

Start

Figure 3-68 Ping

3.7.4 Tracert

Tracert is used to check a route from one IP address to another works normally or not.

Instruction for using Traceroute:

1. Select the network port of SBC300 and its network type (IPv4 or IPv6), enter the destination IP address, and then click **Start**.
2. View the route information from the returned message.

Tracert

Interface: GE0

IPv4/IPv6: IPV4

Destination IP: 172.16.11.22

Start

Figure 3-69 Tracert

3.7.5 Capture

On the **Maintenance** → **Capture** interface, you can capture network packages based on the information you fill in.

First, you are allowed to enter a source IP and a destination IP or domain to capture network packets. When the configured time expires, the SBC will automatically stop capturing packets.

Server Type: Local Server

Filter Group

Type: Customization value

Port Range: 1 ~ 65535

IPv4/IPv6: IPV4

Source IP: 172.21.180.30

Destination IP/Domain: 172.16.0.2

Transport: TCP UDP ICMP ARP

Time: 5 min

Start Stop & Downl

Figure 3-70 Capture Packets by Customized Value

You can also capture the packets of a MFU. In this case, the corresponding port range will be a default value.

Server Type: Local Server

Filter Group

Type: MFU0

IPv4/IPv6: IPV4

Source IP: 172.21.180.30

Destination IP/Domain: 172.16.0.2

Transport: TCP UDP ICMP ARP

Time: 5 min

Start Stop & Downl

Figure 3-71 Capture Packets of MFU

The SBC300 device also supports 'Exact Match' to capture packets. That is to say, you can capture the packets between a specific caller number and a specific callee number. In this case, you need to enter the inbound trunk of the call.

Figure 3-72 Capture Packets Based on Caller/Callee Number

3.7.6 Regular Expression

On the **Maintenance** → **Regular Expression** page, you can test the regular expressions that are used in number manipulation, blacklist, whitelist and SIP header manipulation.

Regular Expression

Regular Expression Test

Regular Expression

Content

Test Matching

Test Result

Example

`^0755` Matches the phone numbers with starting digits of 0755.

`^0755|^8899|^0110` Matches the phone numbers with starting digits of 0755, 8899 or 0110.

`^ [1][358][0-9]{9}$` Matches the phone numbers with the first digit as 1, the second digit as 3, 5 or 8, the left nine digits as any of 0 to 9.

Regular expressions are compatible with PCRE

Figure 3-73 Test Regular Expression

Regex (Regular Expression) Syntax

Table 3-41 Explanation of frequently-used metacharacters in Regex

^	Matches the starting position in a number string. For example, ^134 matches the numbers starting with 134
\$	Matches the ending position of a string. For example, 2\$ matches the numbers ending with 2.
	Separates alternate possibilities. For example, 2 3 4 means 2,3or 4.
\	Marks the next character as a special character, a literal, a backreference, or an octal escape
[]	Matches a single character that is contained within the bracket. For example, [123] matches 1, 2, or 3. [0-9] matches any digit from "0" to "9".
[^]	Matches any one character except those enclosed in []. For example, [^9] matches any character except 9.
.	Matches any single character except the newline character. For example, 3.4 matches 314, 324, 334, 344.
?	Indicates there is zero or one of the preceding element. For example, colou?r matches both color and colour
*	Indicates there is zero or more of the preceding element. For example, ab*c matches ac, abc, abbc, abbbc, and so on.
+	Indicates there is one or more of the preceding element. For example, ab+c matches abc, abbc, abbbc, and so on, but not ac
\d	Mark any digit, equal to [0-9]
\D	Mark any character that is not a digit, equal to [^0-9]
\s	Mark any blank character such as a space or a tab.
\S	Mark any character that is not a blank character

3.7.7 Warning

If a call triggers the monitoring rules configured on the **Service → Quality Monitoring** page and ‘Action’ is selected as ‘Warning’ on that page, warning logs will be given and can be seen on the **Maintenance → Warning** page.

Index	Name	Time	Alarm Level	Classes	content	WarningType	Source	confirm
1	eth90	2019-07-10 10:17:42	Urgent	system	eth90 is connected	repair	eth90state	unconfirmed <input type="checkbox"/>
2	eth90	2019-07-10 02:37:20	Urgent	system	eth90 is not connected	alarm	eth90state	unconfirmed <input type="checkbox"/>
3	eth90	2019-07-09 08:11:16	Urgent	system	eth90 is connected	repair	eth90state	unconfirmed <input type="checkbox"/>
4	eth90	2019-07-09 08:01:46	Urgent	system	eth90 is not connected	alarm	eth90state	unconfirmed <input type="checkbox"/>

Figure 3-74 Warning list

3.7.8 SNMP Configuration

The SBC300 device of Dinstar supports three SNMP versions, namely v1, v2c and v3.

The screenshot shows a configuration form for SNMP. At the top, there are two radio buttons: 'Yes' (selected) and 'No'. Below that, there is a dropdown menu for 'SNMP Version' currently showing 'v2c'. Underneath, there is another dropdown menu for 'SNMP port' with 'v1' selected. The 'v2c' option is also visible below the 'v1' option in the dropdown.

1. Community Configuration

This configuration item exists in v1 and v2c. You need to configure the values of “Community” and “Source”. Community is a character string, serving as the password for SNMP authentication, while source is the IP address of SNMP server.

The screenshot shows a configuration form titled 'Community configuration'. It has two columns: 'Community' and 'Source address'. There are three rows of input fields. Below the table, there is a red note: 'Note: The default value of the source address is default. If not, input the IP address!'.

2. Community Group

This configuration item exists in v1, v2c and v3. You need to configure the value of “Group” and select a community that has been created before.

Group is also a character string. Add a community into a group and then configure different access permission for each group in the following step of access configuration.

The screenshot shows a configuration form titled 'Community group'. It has two columns: 'Group name' and 'Community'. There are three rows of input fields. The 'Community' column contains dropdown menus.

3. Mid View Configuration

This configuration item exists in v1, v2c and v3, and you need to configure the values of “View Name”, “View Type”, “View Subtree” and “View Mask”.

View name is a character string used to identify this view. As for view type, if “included” is selected, the OID of mib tree is included in this view; if “excluded” is selected, the OID of mib tree is excluded from this view. View Mask is used to extract a row of a table, for example, it can be a mask of an Ethernet port.

mib view configuration

View Name	View Type	Mib Tree	Mask
<input type="text"/>	<input type="text" value="v"/>	<input type="text"/>	<input type="text"/>
<input type="text"/>	<input type="text" value="v"/>	<input type="text"/>	<input type="text"/>
<input type="text"/>	<input type="text" value="v"/>	<input type="text"/>	<input type="text"/>

Note: The format of the mib tree: x.x.x.x.x, if there is only one x, the format is: .x(x is a positive integer)

4. Access Rule Configuration

This configuration item exists in v1, v2c and v3. You need to select a group that has been created and then select view names for “read”, “write” and “notify”.

Access rule configuration (v1/v2c)

Group name	Read View	Write View	Trap View
<input type="text" value="v"/>	<input type="text" value="v"/>	<input type="text" value="v"/>	<input type="text" value="v"/>
<input type="text" value="v"/>	<input type="text" value="v"/>	<input type="text" value="v"/>	<input type="text" value="v"/>
<input type="text" value="v"/>	<input type="text" value="v"/>	<input type="text" value="v"/>	<input type="text" value="v"/>

5. Trap Configuration

This configuration item exists in v1, v2c and v3. You need to configure the IP address, port, and community of the destination SNMP server where alarm information is sent. There are three trap types, including v1,v2c and inform.

Trap configuration

Trap Type	IP Address	Port	Community
<input type="text" value="v2c"/>	<input type="text"/>	<input type="text" value="162"/>	<input type="text" value="public"/>

4 Abbreviation

SBC: (Session Border Controller)

SIP: (Session Initiation Protocol)

DTMF: (Dual Tone Multi Frequency)

NAT: (Network Address Translation)

VLAN: (Virtual Local Area Network)