



**Shenzhen Dinstar Co., Ltd.**

Address: Floor 18, Building 7A, Vanke Cloud City Phase 1, Xingke 1st Street, Xili Sub-district, Nanshan District, Shenzhen.

Postal Code: 518052

Telephone: +86 755 61919966

Fax: +86 755 2645 6659

Email: [sales@dinstar.com](mailto:sales@dinstar.com)

Website: [www.dinstar.com](http://www.dinstar.com)

# Preface

---

## Welcome

Thanks for choosing the C62U/C62UP IP phone! We hope you will make full use of this rich-feature IP phone, Contact us if you need any technical support:0755-61919966.

## About This Manual

This manual provides information about the introduction of the IP phone, and about how to install, configure or use it. Please read this document carefully before install the C62U/C62UP IP phone.

## Intended Audience

This manual is aimed primarily at the following people:

- Users
- Engineers who install, configure and maintain the C62U/C62UP IP phone.

## Revision Record

Document Name	Version	Firmware Version
C62U/C62UP IP Phone User Manual	V1.0	V2.62.6.2.1

## Conventions

The phone or device mentioned in this document refers to the C62U/C62UP IP phone. "Note" marked in the document is what users need to pay attention to.

# Contents

<b>1 Overview .....</b>	<b>7</b>
1.1 Introduction.....	7
1.2 Feature .....	7
1.3 Hardware Introduction .....	9
1.3.1 Front View and Keypad Description.....	9
1.3.2 Rear View and Panel Descriptions.....	10
1.3.3 Screen and Icons .....	11
<b>2 Installation.....</b>	<b>12</b>
2.1 Inspection.....	12
2.2 Installation .....	12
<b>3 Functions.....</b>	<b>14</b>
3.1 Making a Call.....	14
3.1.1 Call Modes.....	14
3.1.2 Methods to Make Calls .....	14
3.2 Answering the Call .....	16
3.3 Silencing or Rejecting the Call .....	17
3.4 Ending Calls.....	18
3.5 Mute.....	18
3.6 Holding and Resuming Call.....	19
3.7 DND.....	19
3.8 Call Waiting .....	21
3.9 Call Completion .....	21
3.10 Call Forward .....	22
3.11 Call Transfer .....	24
3.11.1 Blind Transfer .....	24
3.11.2 Semi-Attended Transfer.....	24
3.11.3 Attended Transfer .....	25
3.12 Conference Calls.....	25
3.12.1 Local Conference.....	25
3.12.2 Network Conference .....	27
3.13 Call Park .....	27
3.13.1 Call Park and Call Retrieve .....	27
3.14 Pickup .....	28
3.14.1 Directed Pickup .....	28

3.14.2 Group Pickup .....	29
3.15 Speed Dial .....	29
3.16 Auto Redial .....	29
3.17 Intercom .....	30
3.18 Hot Desking .....	30
3.19 XML Browser .....	31
3.20 Call Recording .....	31
3.21 Keypad Lock .....	32
3.22 BLF .....	33
3.22.1 Setting a BLF Key .....	33
3.22.2 Picking Up a Call by BLF Key .....	34
3.22.3 Blind Transfer a Call by BLF Key .....	34
3.22.4 Attended Transfer a Call by BLF Key .....	34
3.23 BLF List .....	35
3.24 Automatic Call Distribution (ACD) .....	35
3.25 Call Return .....	35
3.26 Messages .....	36
3.26.1 Text Message .....	36
3.26.2 Voice Message .....	37
<b>4 Settings .....</b>	<b>38</b>
4.1 Basic settings .....	38
4.1.1 Language .....	38
4.1.2 Date & Time .....	39
4.1.3 Ring Tones .....	40
4.1.4 Phone Volume .....	40
4.1.5 Backlight .....	41
4.1.6 Screensaver .....	41
4.2 Phone Book .....	41
4.2.1 Local Phone Book .....	41
4.2.2 Blacklists .....	43
4.2.3 Remote Phone Book .....	43
4.3 History Management .....	44
4.4 Customizing your phone .....	44
4.4.1 Programmable Keys .....	44
4.4.2 SIP Account Management .....	44
4.5 Basic Network Settings .....	45
4.5.1 LAN Mode .....	45

4.5.2 DHCP Mode .....	45
4.5.3 Static IP Mode .....	46
4.5.4 PPPoE Mode.....	46
4.5.5 Configuring VLAN.....	46
4.6 Web Server.....	47
4.7 Reset to Factory .....	47
4.8 Password Setting.....	47
4.9 Auto Provision .....	48
4.10 Reboot.....	48
<b>5 Web Platform .....</b>	<b>49</b>
5.1 Login & Logout .....	49
5.2 Status.....	50
5.2.1 Status->Basic .....	50
5.3 Account.....	51
5.3.1 Account->Basic .....	51
5.3.2 Account->Advanced.....	54
5.3.3 Account-> Audio Codecs.....	59
5.4 Network .....	60
5.4.1 Network->Basic.....	60
5.4.2 Network-Advanced.....	61
5.4.3 Network ->TR069.....	62
5.4.4 Network ->SNMP.....	63
5.4.5 Network ->NMS .....	64
5.4.6 Network ->VLAN&QoS .....	64
5.4.7 Network ->802.1X.....	66
5.4.8 Network ->Diagnosis.....	67
5.5 Phone .....	68
5.5.1 Phone->Basic.....	68
5.5.2 Phone-Time&Date .....	69
5.5.3 Phone- Call Feature .....	71
5.5.4 Phone-Voice.....	72
5.5.5 Phone->Key.....	74
5.5.6 Phone-Ringtones.....	75
5.5.7 Phone-Tones .....	76
5.5.8 Phone ->Dial Plan Rule .....	76
5.5.9 Phone-Action URL .....	79
5.5.10 Phone ->Multicast.....	81
5.5.11 Phone->Forward & DND .....	82

5.5.12 Phone->Intercom .....	84
5.5.13 Phone->ACD .....	85
5.6 PhoneBook.....	86
5.6.1 PhoneBook -> Local Book .....	86
5.6.2 PhoneBook -> Remote Book .....	87
5.6.3 PhoneBook -> Call History .....	88
5.6.4 PhoneBook -> LDAP.....	89
5.6.5 PhoneBook -> Broadsoft .....	91
5.7 Upgrade.....	92
5.7.1 Upgrade->Upgrade .....	92
5.7.2 Upgrade-Auto Provision.....	92
5.7.3 Upgrade->System Log.....	94
5.7.4 Upgrade->Network Capture .....	94
5.7.5 Upgrade->Configuration.....	95
5.7.6 Upgrade->PnP .....	95
5.7.7 Upgrade->Custom Language.....	96
5.8 Security .....	97
5.8.1 Security->Basic .....	97
5.8.2 Security->Advanced .....	98
5.8.3 Security->Firewall .....	99
<b>6 Troubleshooting.....</b>	<b>100</b>
<b>7 Appendix.....</b>	<b>101</b>
7.1 Abbreviations.....	101
7.2 Time Zones .....	102

# 1 Overview

---

## 1.1 Introduction

C62U/C62UP IP phone is an entry-level multi-functional high-definition IP phone. With its simple design, cost-effective and convenient management and maintenance, it brings an excellent experience for users. Its HD voice and rich system functions fully meet the needs of small and medium-sized enterprises, call centers and industry users.

The C62U/C62UP SIP phone has a 2.4"240 x 320 pixel TFT LCD with Backlight. It supports 6 SIP accounts, supports 5-party conference, and realizes rich business functions through cooperation with IPPBX. At the same time, programmable keys and advanced functions allow users to effectively save time and easily achieve office work.

## 1.2 Feature

### ➤ Highlights

- HD Voice
- 6 SIP Accounts
- 2.4"240×320 pixel TFT LCD with Backlight
- Support five-way Conference
- Full Compatible with 3CX, Asterisk, BroadSoft Platform
- Dual 10/100/1000Mbps Power over Ethernet (PoE IEEE802.3af)

### ➤ Phone Features

- 2 Lines (support 2 IP accounts)
- Support Call Waiting, Call Forwarding, Call Transfer
- Auto Redial, Call Return, Auto-answer, Redial,
- Call on Hold, Mute, DND
- Support five-way Conference
- Adjustable Volume, Selectable Ring Tones
- Speed Dial, Hotline
- Daylight Saving Time
- Network Packet Capture
- Country Ringtone Signal
- Direct IP call (Calling to IP Address)
- Dial Plan
- XML Browser

- Hot Desking
- Keypad Lock
- Action URL/URI
- Phonebook (1000 entries), Blacklist (100 entries), call logs (100 entries)
- 5 Remote Phone Book URL supported
- LDAP
- Multi-Language Support
- Multicast listening
- **IP-PBX Feature**
  - SMS, Voicemail, MWI Message Notification
  - Music on hold, Intercom
  - BLF (Busy Lamp Field)
  - Call Pickup, Call Pickup in Group
  - Call Recording
  - Anonymous Call, Anonymous Call Rejection
- **Network Features**
  - SIP V1(RFC2543), V2(RFC3261)
  - Static IP/DHCP/PPPoE for IP configuration
  - 3 DTMF modes: In-Band, RFC2833, SIP INFO
  - HTTP/HTTPS Web Server for Management
  - NTP for Auto Time Setting
  - TFTP/FTP/HTTP/HTTPS Protocols
  - 802.1Q VLAN
  - 802.1X
  - Open VPN
- **Administration Features**
  - Auto provisioning using FTP/TFTP/HTTP/HTTPS
  - Dial through IP PBX Using Phone Number
  - Configuration Managements with Web platform, settings on the phone, and Auto Provisioning
  - SNMP
  - TR069
  - Equipment Management System (NMS)
- **Security Features**
  - HTTPS (SSL)



- SRTP for Voice Data Encryption
- Login for Administration
- SIP Over TLS

## 1.3 Hardware Introduction

### 1.3.1 Front View and Keypad Description

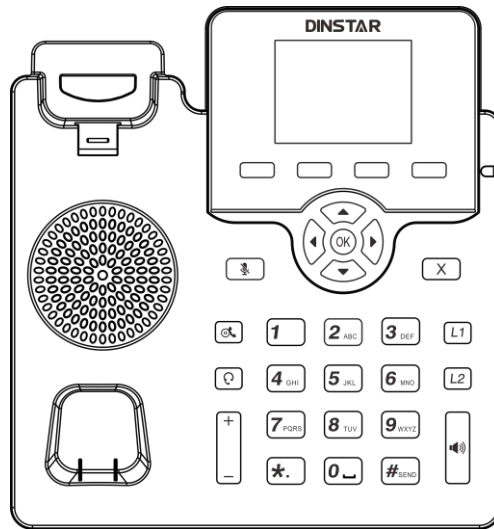

Name	Description
LCD Screen	Shows information about calls, messages, soft keys, time, date, and so on.
Power LED Indicator	The power indicator indicates the call, message and system status: Solid blue: The phone is idle. Fast-flashing blue: The phone is ringing. Slow-flashing blue: The phone receives a message.
Cancel/Reject Key	Cancel the current actions or used as the return key
Line Keys	When used as a programmable key or activated account, multiple functions can be configured.
Soft Keys	Used to complete the operations about the soft key labels which are displayed on the LCD screen. The labels include: History、Favorites、Redial、Call Return、Hot Desking、XML Browser、DND、Menu、MSG、Status、Book、FWD、Pickup、Intercom、Speed Dial、and so on.
Navigation Keys	Assists you in selecting an item that you want to process under the menu by pressing the Up, Down, Right or Left key. Press the OK key to save.

Name	Description
Hold Key	Press this key during an active call, and you can place a call on hold.
Mute Key	Toggles the microphone on or off
Speakerphone Key	Press this key to activate the speakerphone mode, and you can make the call hand-free.
Keypad	Provide digits, letters and special characters in context-sensitive application.
Volume +/-	Turn down or turn up the volume by pressing the “-” key or the “+” key.
Headset Key	Use the headset key to activate headset mode.
Speaker	Provides hands-free (speakerphone) audio output.
Hookswitch Tab	Secures the handset in the handset cradle when the IP phone is mounted vertically.
Hookswitch	<ul style="list-style-type: none"> <li>• Picking up the handset from the handset cradle, the hookswitch bounces and the phone connects to the line.</li> <li>• Put the handset down on the handset cradle, the phone disconnects from the line.</li> </ul>

### 1.3.2 Rear View and Panel Descriptions

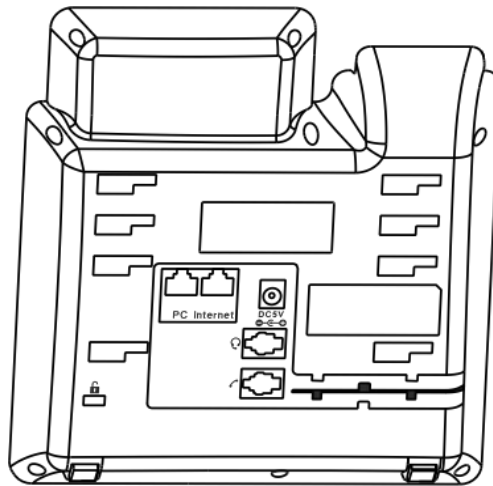

Name	Description
Power Port	Connect to power adapter (Input: 5V DC 1A)
Internet Port	Connect to Network (10/100/1000M)

Handset Port	Connect to handset (Port type: RJ-9 connector)
Headset Port	Connect to headset (Port type: RJ-9 connector)

### 1.3.3 Screen and Icons

The idle screen consists of status bar, line keys, soft keys, etc., as shown in the figure below:

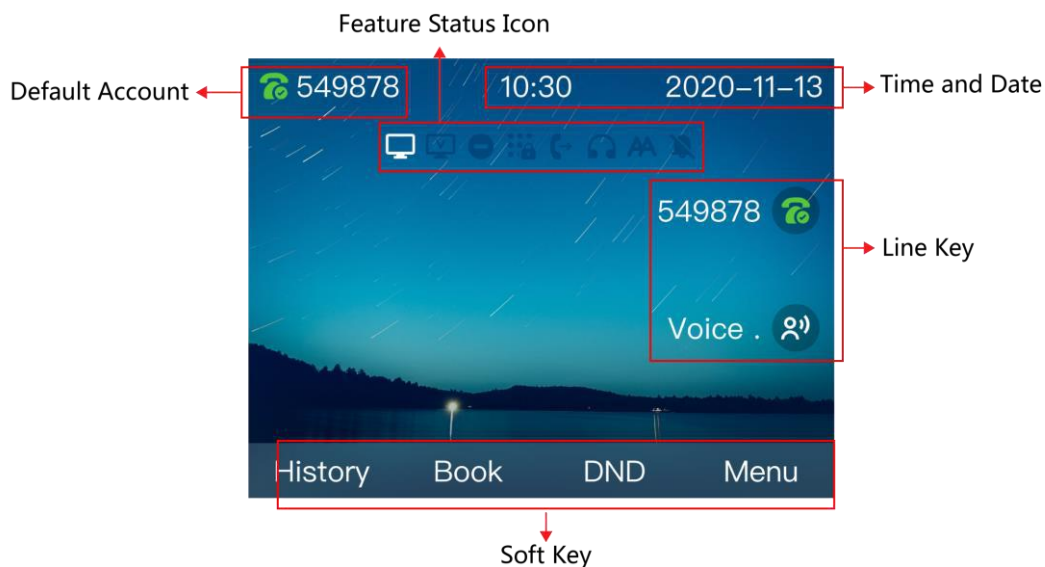

The icons displayed on the screen are as follows:

Icons	Description	Icons	Description
	Registered		muted
	Register failed		Headset mode
	Registering		Speakerphone mode
	Register Disabled		Handset mode
	Auto answer		New text message
	Do Not Disturb		New voice message
	Forward		Miss calls
	Network Disconnection		Keypad Lock

# 2 Installation

## 2.1 Inspection

Check the device and accessories with the device as per list of packing (See the table below).

Note: If the IP phone is powered by PoE, no power adapter will be provided.

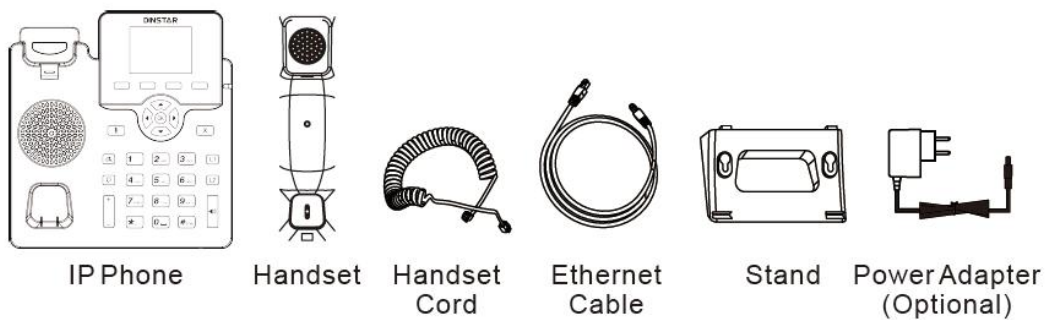

Name	Quantity
C62U/C62UP IP Phone	1
Stand	1
Handset	1
Handset cord	1
Power Adapter (Optional)	1
Ethernet Cable	1

## 2.2 Installation

### Step 1: Installing the stand

C62U/C62UP IP phone supports two installation methods, as shown in the figure below. You can choose slot A or slot B according to your habits and environment. Align the stand with the slot and push it to the top evenly, make sure it is fixed;

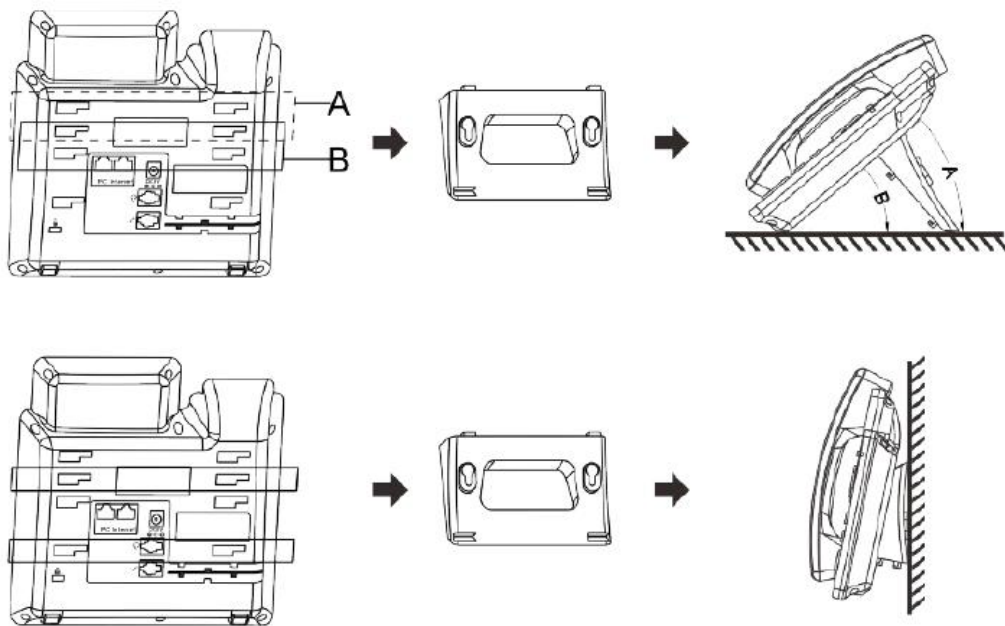

**Step 2: Connecting power, Internet and handset**

- 1) Connect the provided power adapter to the power port, and plug the other end of the adapter into an available power socket. After the power is connected, the LCD screen of the phone displays "Welcome, please wait...";
- 2) Connect one end of the Ethernet cable to the Internet port on the back of the C62U/C62UP phone, and the other end to the network jack.
- 3) Connect one end of the Handset cord to the handle, and the other end to the Handset port, as shown in the figure below.

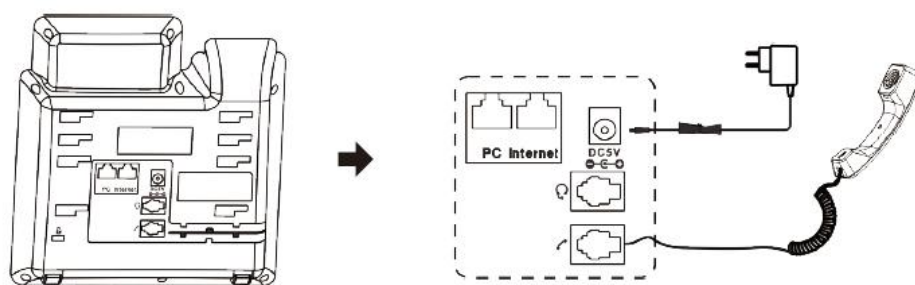

**Note:** Never use a power adapter other than the one provided with Dinstar C62U/C62UP; Internet port supports POE.

**Step 3-Getting Started**

After the phone is connected to the power and network, the phone will automatically start up and the common functions of the phone can be used normally (see section 3





for more details). You can customize more functions through the Web platform or settings (see section 4 & 5 for more details).

# 3 Functions

## 3.1 Making a Call

### 3.1.1 Call Modes

You have the following three ways to make a call.

- 1) **Handset mode:** Pick up the handset, the  icon will be displayed in the upper left corner of the screen. And then enter a number or select a contact.
- 2) **Speakerphone mode:** Press the **Speakerphone Key** , the  icon will be displayed in the upper left corner of the screen. And then enter a number or select a contact.
- 3) **Headset mode:** Press the **Headset Key**  after the headset is connected to the headset port. The  icon will be displayed in the middle of the screen. And then enter a number or select a contact.



You can also enter a number first, and then choose the method you will use to speak to the other party.

### 3.1.2 Methods to Make Calls

#### Making a call from the Dialer

According to the number you input from the dial pad, the screen will display the previously saved contacts. You can select the contact you want to call from the list, or enter the number you want to call directly.

#### Procedure



- 1) Do one of the following:
  - Enter the number from the dial
  - Select the line key to be called
  - First take off the handle or press the **Speakerphone Key** ; and enter the number you want to call or select from the contact list;
- 2) Press soft key **Send** or select **Dial Key**  from keypad.

**Note:** You can set the dial key through *Menu>Function>Dial Key*.

### Making multiple calls

During the call, you can keep the current call and then make other calls.



#### Procedure

- 1) Do one of the following:
  - Select a line key to keep the current call;
  - Press the **Hold Key**  to hold the current call;
- 2) Enter the number you want to call or select from the displayed contact list;
- 3) Press soft key **Send** or select **Dial Key**  from keypad.

### Making a call with Speed Dial Key

You can use speed dial keys to call the number you dialed often or the number which it is hard to remembered. The steps for setting the quick dial key are as follows:



#### Procedure

- 1) Navigate to *Menu>Features>Programmable Keys*;
- 2) Select the **Line Keys**;
- 3) Pick a line key from the list
- 4) Press the **up**  /  **down** navigation key or the **Switch** soft key in the type bar to select **Speed Dial**;
- 5) (Optional) Enter the name that will be displayed on the screen in the label bar;
- 6) Enter the number that will be set as the speed dial in the value field
- 7) In the account field, select the account that is set as a speed dial key and used for outgoing calls;
- 8) Select the **Save** soft key to complete the setting.

### Calling back the last call

You can use the redial key to quickly dial the last call.



#### Procedure

- 1) Navigate to *Menu>Features>Programmable Keys*;
- 2) Select the **Line Keys**;
- 3) Pick a line key from the list
- 4) Press the **up**  /  **down** navigation key or the **Switch** soft key in the type bar to select **CallReturn**;
- 5) (Optional) Enter the name that will be displayed on the screen in the label bar;
- 6) Select the **Save** soft key to complete the setting.

### Making a call from the history list

You can call the number directly from the history list. The history record includes all dialed calls, received calls, missed calls, and forwarded calls.

**Procedure**

- 1) Select **History** soft key or navigate to *Menu> History*, all call records will be displayed on the screen;
- 2) Press the **up**  /  **down** navigation key to select the number you want to redial;
- 3) Select **Dial** soft key.

**Making a call from the contact list**

You can call directly from the contact list

**Procedure**

- 1) Select the **Book** soft key or navigate to *Menu> Book > Local Phone Book*;
- 2) Select the group or contact you want to call;
- 3) Select **Dial** soft key.



## 3.2 Answering the Call

**Manually answer a call**

The phone will ring when receiving an incoming call. You can answer the call manually.

**Procedure**

Do one of the following:

- Pick up the handset to answer;
- Press the Speakerphone Key  to answer;
- Press the Headset Key  to answer;
- Press the Answer soft key or press the line keys that is flashing green. In this case, the speakerphone mode will be activated to answer incoming calls.

**Answering a new incoming call**

You can answer a new incoming call while you are on a call. When there is a new incoming call, the phone emits a "beep" and the screen shows the incoming information, and the green light of the incoming line key flashes.



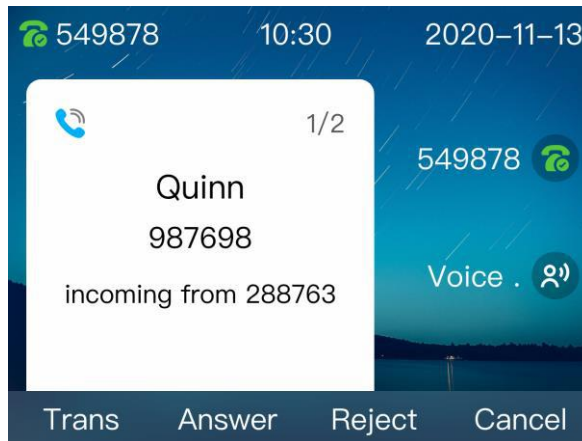

**Procedure**

After selecting the **Answer** soft key to answer the new call, the previous call is put on hold

**Auto answer**

When the phone is idle, you can enable the speakerphone mode to automatically answer incoming calls.

**Procedure**

- 1) Navigate to *Menu > Settings > Advanced Settings (password: admin)*;
- 2) Select the account that you want to activate auto answer and click the **Enter** soft key;
- 3) In the auto answer bar, select **Enable** by the soft key **Switch**;
- 4) Select **Save**.

1. After the account is enabled for auto answer, when the account is selected as the default account, the phone screen will display the auto answer icon.
2. When there is an incoming call during a call, the new call will not be answered immediately even if the automatic answering function is turned on.

**Note:**

1. After the account is enabled for auto answer, when the account is selected as the default account, the screen will display the auto answer icon **AA**.
2. When there is an incoming call during a call, the new call will not be answered immediately even if the auto answer is enabled.

### 3.3 Silencing or Rejecting the Call

You can ignore or reject the call when you receive an incoming call.

**Silencing call**

If you ignore the incoming call, the phone will no longer ring, but the incoming call information is still displayed on the phone screen.

### Procedure

Select the **Mute** soft key or press the **Mute Key** .

### Manually reject calls

When the phone receives an incoming call, you can reject it. The rejected call will be displayed in the history of received calls.

### Procedure

Select the **Reject** soft key to reject the incoming call.

### Using Do Not Disturb (DND) to reject all calls

If you don't want to be disturbed by incoming calls, you can use the Do Not Disturb function to automatically reject all incoming calls or all incoming calls from a specified account. For details, please refer to 3.7 Do Not Disturb> Enable Do Not Disturb in Default Mode.

### Using the Do Not Disturb (DND) to reject all calls from a specified account

By default, the DND mode applies to all accounts. You can set the mode through the web system to enable the DND function of a specific account. For the specific configuration, please refer to 3.7 DND> Enable Do Not Disturb in Custom Mode.

## 3.4 Ending Calls

You can end the current call at any time.

### Procedure



Do one of the following:

- If the phone works in handset mode, press the **Cancel** soft key or hang up the call;
- If the phone works in headset mode, press the **Cancel** soft key;
- If the phone works in speakerphone mode, press the **Speakerphone key**  or press the **Cancel** soft key.

## 3.5 Mute

When you enable the mute function during a call, the other party will not receive your voice message, but you can.

### Procedure

- 1) Press the **Mute Key**  to enable the mute function, the other party will not hear you, but you can. At this time, the mute icon  is displayed on the LCD screen;
- 2) Press the **Mute Key**  again to disable the mute mode.

## 3.6 Holding and Resuming Call

You can put a call on hold and resume the call at any time. The held party may hear the music sent from the PBX server while waiting.

### Procedure

- 1) During the call, press the **Hold Key**  or select the soft key **Hold**. At this time, the screen will flash the hold icon and information;

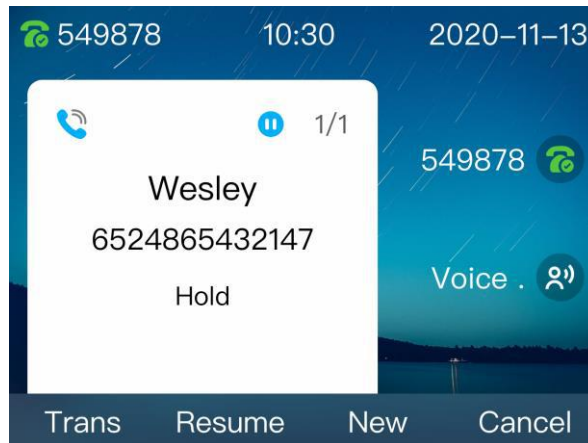

- 2) Press the **Hold Key**  again or select **Resume** to resume the call.

### Note:

When there are multiple calls, you can switch to a different line call by pressing the corresponding line.

## 3.7 DND

If you don't want to be disturbed by incoming calls, you can set the DND function. The DND feature is applicable to all accounts and can also be directed to a specific account. And we also provide you with a DND Timer Enable.

The DND setting depends on the phone mode: phone mode or custom mode (the default is phone mode). In the phone mode, the DND function will be enabled for all accounts of the phone; in the custom mode, the DND function can be set for a specific account. Both the mode needs to be set on the web system.

### DND function is enabled in default mode

#### Procedure

Do one of the following:

- Select the soft key **DND**, the screen will display the DND icon  in the middle of the screen;
- Navigate to **Menu > Features > DND Code**.
  - 1) Select to **Enter** soft key;
  - 2) Select the **Switch** soft key to enable the DND function;

- 3) (Optional) Input the value in the area of On code and Off code;
- 4) Select **Save**.

After the setting is complete, the screen will display the DND icon , which will not change when switching between different accounts to the current default account.

### DND function is enabled in custom mode

#### 1、 Setting custom mode on the Web page



You can log in to the phone with the account User, Navigate to Phone> Forward & DND , as shown in the figure below. Select the phone mode on this page, and click **Submit** to save the configuration.

Sync Feature Code	
Active	Disabled 
Mode	<input type="radio"/> Phone <input checked="" type="radio"/> Custom

#### 2、 Enabling DND for specific accounts

##### Procedure

- 1) Navigate to *Menu> Features> DND Code*;
- 2) Select an account;
- 3) Enable DND function;
- 4) (Optional) Input the value in the area of On code and Off code ;
- 5) Select **Save**.

When you use the up and down navigation keys   to switch between different accounts as the default account, the account that has set the DND function will display the DND icon  on the screen.

### DND timer enable

You can enable the DND timer according to your work and rest habits, and reject all calls during the period you set. There are three sets .The ranges of the three periods can overlap.

Log in to the phone with the account User, navigate to Phone> Forwarding & DND, set DND Timer to Enable, then set the period, and finally select Submit to save the configuration.

DND	
Account	Account 1
DND	Enabled
Return Code When DND	486 (Busy Here)
DND On Code	
DND Off Code	
DND Timer Enable	Enabled
DND Timer 1	0 Hour 0 Min - 23 Hour 59 Min
DND Timer 2	0 Hour 0 Min - 23 Hour 59 Min
DND Timer 3	0 Hour 0 Min - 23 Hour 59 Min

### Disabling DND

When you need to answer a call, you can disable the DND function.

#### Procedure

- 1) Navigate to *Menu > Features > DND Code*;
- 2) Select a specified account or select all accounts;
- 3) Disable the DND function;
- 4) (Optional) Input the value in the area of On code and Off code
- 5) Select Save.

After the setting is completed, the DND icon  will disappear from the screen.

## 3.8 Call Waiting

You can enable the call waiting function so that you can answer new calls during the call, otherwise, the new call will be automatically rejected and a busy tone will be displayed. You can enable the call waiting tone function at the same time. When you receive a new call during a call, The phone will emit a "beep" tone to indicate a new call.

#### Procedure

- 1) Navigate to *Menu > Features > Call Waiting*.
- 2) Select to **Enable** call waiting.
- 3) (Optional) Select to **Enable** tone.
- 4) Select **Save**.

## 3.9 Call Completion

When you fail to call out, you can use the call completion function to monitor the called party and re-establish the call when the called party is free.

#### Note:

Not all servers support the call completion. Please consult your system administrator for further information.

#### Procedure

- 1) Navigate to **Menu > Features > Call Completion**.
- 2) Enable call completion.
- 3) Choose **Save**.

When you initiate a call and the called party is busy and does not answer, the screen prompts you whether to wait for the called party, select OK to activate the call completion function.

When the called party is idle, the screen prompts you whether to initiate a call. Selecting OK will initiate the call again.

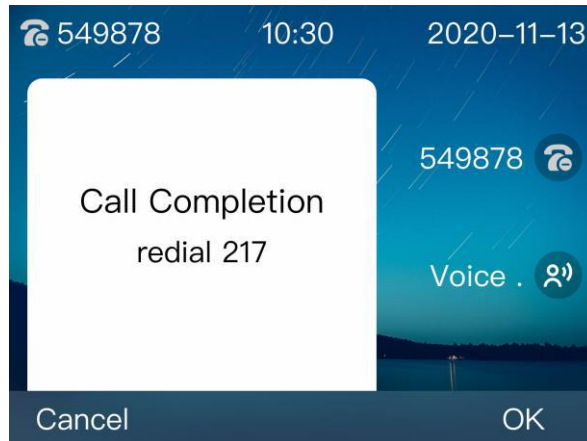

## 3.10 Call Forward

When you cannot handle the incoming call in time, you can forward the incoming call to an available number.

Setting the type of forwarding calls:

**Always Forward:** All incoming calls will be automatically forwarded to the pre-configured number

**Busy Forward:** When the phone is busy, the incoming call will be forwarded to the pre-configured number

**No Answer Forward:** When the phone does not answer within the set time, the incoming call will be forwarded to the pre-configured number.

### Forwarding all calls

After enabling call forwarding, you can forward all incoming calls on the phone. The activation method is as follows:

**Note:** Some servers need to set the enable code and the disable code for call forwarding. Please consult your system administrator for further information.

### Procedure

- 1) Navigate to **Menu > Features > Call Forward**;
- 2) Select a call forwarding type, and then select **Enable** in the active bar;
- 3) Enter the number to be forwarded in the forward to area;

- 4) If you choose no answer forward, enter the time in the timeout bar;
- 5) (Optional) Input the value in the area of On code and Off code;
- 6) Select **Save**.

After configuring call forward, the call forward icon  is displayed on the screen.

### Forwarding the call to the designated account

By default, enabling call forwarding applies to all accounts. You can enable call forwarding for specific account by setting the phone mode.

#### ① Setting the custom mode on the Web page

You can log in to the Web with the account user, navigate to **Phone > Forwarding & DND**, set the phone mode to Custom , and select Submit to save the configuration.

Sync Feature Code	
Active	Disabled <input type="button" value="v"/>
Mode	<input type="radio"/> Phone <input checked="" type="radio"/> Custom

#### ② Setting call forward for designated account on the phone

##### Procedure

- 1) Navigate to **Menu > Features > Call Forward**;
- 2) Select a call forwarding type, and then select **Enable** in the active bar;
- 3) Select an account;
- 4) Enter the number to be forwarded in the forward to area;
- 5) If you choose no answer forward, enter the time in the timeout bar;
- 6) (Optional) Input the value in the area of On Code and Off Code;
- 7) Select **Save**.

After configuring call forward, the call forward icon  is displayed on the screen.

### Disabling call forward.

When you no longer need to forward incoming calls, you can choose to disable the call forwarding.

##### Procedure

- 1) Navigate to **Menu > Features > Call Forward**;
- 2) (Optional) If the call forward works in a custom mode, you need to select an account;
- 3) Select the call forwarding type, and then select **Disable** in the active bar;
- 4) Select **Save**.

### Forwarding a call by hand

You can also select the soft key **Forward** to forward the call to someone else when the call is ringing.

#### Using the soft key **Forward**

##### Procedure

- 1) When the phone is ringing, select the soft key **Forward**;
- 2) Enter the number to be forwarded or select the number from the book;
- 3) Press the **OK key** .

Incoming calls forwarded will be marked as forwarded calls in the call history.

## 3.11 Call Transfer

You can transfer calls to other during an active call. There are the following three transfer methods:

**Blind transfer:** Transfer the call to a third party directly without prior notice;

**Semi-Attended Transfer:** When you hear the back tone, transfer the call to a third party;

**Attended Transfer:** After the third party answers the call and consults, the call is transferred to the third party.

### 3.11.1 Blind Transfer

You can transfer directly without notifying the third party, as follows:

##### Procedure

- 1) Press the soft key **Trans** during the call;
- 2) Enter the number to be transferred or select a number from the book;
- 3) Press the soft key **Trans** again.

**Note:** If the phone works in handle mode, you can directly put the handle back to complete the transfer.

### 3.11.2 Semi-Attended Transfer:

You can transfer the call to the third party after hearing the back tone.

##### Procedure

- 1) Press the soft key **Trans** during the call;
- 2) Enter the number to be transferred or select a number from the book;
- 3) Press **OK key**  or **Send** soft key;
- 4) After hearing the ring back, press the soft key **Trans** again to complete the semi-attended transfer.



**Note:**

You can directly put the handle back to complete the transfer in the handset mode.

### 3.11.3 Attended Transfer

You can transfer the call to the third party after hearing the back tone.

**Procedure**

- 1) Press the soft key **Trans** during the call;
- 2) Enter the number to be transferred or select a number from the book;
- 3) Press **OK key**  or **Send** soft key;
- 4) After the third party answers and consults, press the soft key **Trans** again to complete the attended transfer

**Note:**

You can directly put the handle back to complete the transfer in the handset mode.

## 3.12 Conference Calls

The phone supports the creation of three-party local conferences and multi-party network conferences.

During the conference, please follow the suggestions below:

- If you are attending the conference in public, please use the handset or headset mode.
- Please switch to mute mode when you are not speaking in the meeting
- Avoid knocking near the microphone or close to electronic equipment.
- Please speak at a normal volume.
- Adjust the microphone direction appropriately when there are harsh sounds in speech.

### 3.12.1 Local Conference

You can establish a three-party (including local) conference with your contacts.

**Creating a local meeting**

**Procedure**

- 1) Call the first party;
- 2) After the first party answers, press the soft key **New** to start creating a new call;
- 3) Enter the number of the second party or select the number from the book and call out. The call of the first party is now on hold;

- 4) After the second party answers the call, press the soft key **Conference** to start a three-party conference.

### Merging two calls into a conference

You can merge a on hold call with the current call to form a three-party conference call.



#### Procedure

- 1) Create two calls;
- 2) Select the call you want to create a conference, and ensure that the call is available;
- 3) Press the soft key **Conference** to start.

### Holding or resuming a conference call

When you hold a conference call, the participants in the conference cannot hear the other party until you resume the conference call.



#### Procedure

- 1) Press the **HOLD key**  or press the soft key **Hold** to keep the current conference call;
- 2) Press the **HOLD key**  again or press the soft key **Resume** to resume the current conference call.

### Muting or unmuting a conference call

The microphone is turned off when you mute a conference call, and other parties cannot hear yours.

#### Procedure

- 1) Press the **MUTE key**  to turn on mute during the conference;
- 2) Press the **MUTE key**  again to unmute.

### Splitting a conference call

You can split the current conference call into independent calls. After splitting, the conference call ends, other participants are on hold.

#### Procedure

In the conference, select the soft key **Separate** to end the conference and split the participants into two calls.

### Ending conference call

During the meeting, you can manually end the meeting at any time. If you end the conference call, the conference of other participants will also end.

#### Procedure

Select the soft key **Cancel** or hang up the handset when using the handset or press the Speakerphone key  in the Speakerphone mode to end the conference call.

## 3.12.2 Network Conference

If your administrator has set up the network conference function for your phone, you can create a multi-party network conference locally.

### Create a network conference

#### Procedure

- 1) Call the first party;
- 2) After the first party answers, press the soft key **New** to start creating a new call;
- 3) Enter the number of the second party or select the number from the book and call out. The call of the first party is on hold now;
- 4) After the second party answers, press the soft key **Conference** to start a three-party conference;
- 5) Select the soft key Conference again to invite other members. The conference call is on hold now;
- 6) Enter the invited number or select the number from the book and call out;
- 7) After the new member answers, select the Conference again and add the new;
- 8) Repeat steps 5-7 to add more members.

#### Note:

The method of creating a multi-party conference may vary depending on the server. Please consult your administrator for more information.

## 3.13 Call Park

You can use the call park function to maintain the current conversation, and then resume the call on another. According to different parking modes, it can be divided into code mode and call transfer mode.

#### Note:

Not every server supports call park and the support methods are also different. Please contact your administrator to confirm whether this feature is available.

### 3.13.1 Call Park and Call Retrieve

#### Parking a call in the park code mode

You can use this feature to park a call, and then retrieve the call either from your phone or another phone. After you park a call, the call is placed on hold, you can continue the conversation after retrieving it.

#### Procedure

- 1) Make a call;
- 2) During the call, the parked party enters the park code on the keyboard and sends it;

- 3) Hang up the call after listening to the park number. At this time, the other party is on hold;
- 4) On another phone, enter a park code or an extension number and send;
- 5) Resume the parked call on the new phone.

**Note:**

The above steps will be slightly different according to the different server implementation. If you need this feature, please confirm with your administrator.

### Parking a call in the transfer mode

You can park the call at the location specified by the server by transferring the call.

**Procedure**

- 1) Navigate to *Menu > Features > Programmable Keys > Line Keys/ Soft Keys/ Function Keys*
- 2) (Take line keys as an example) Select a line key and then select **Enter**, select **Call Park** in the type bar;
- 3) (Optional) Enter the information displayed on the screen in the label bar;
- 4) Enter the park code + extension number in the value area;
- 5) Select **Save**.

## 3.14 Pickup

You can use the pickup feature to answer calls from others. There are following two pickup modes:

**Directed Pickup:** Answer incoming calls from designated number.

**Group Pickup:** Pickup calls from any member in the same group. Group pickup needs to set up group members in advance.

### 3.14.1 Directed Pickup

You can answer incoming calls from a designated number.

**Procedure**

- 1) Navigate to *Menu > Features > Programmable Keys > Line Keys/ Soft Keys/ Function Keys* and select the soft key **Enter**;
- 2) (Take the line keys as an example) Select a line key and then select **Enter**, and select **Pickup** in the type bar;
- 3) (Optional) Enter the information displayed on the screen in the label bar;
- 4) Enter the pickup code in the value area and the account to be picked
- 5) Select **Save**.

When the designated number receives an incoming call, press the pickup key to allow the user's incoming call to be answered on your phone.

### 3.14.2 Group Pickup

You can answer an incoming call in the same group. If the group receives multiple incoming calls, it will answer the first by default.

#### Procedure

- 1) Navigate to *Menu > Features > Programmable Keys > Line Keys/ Soft Keys/ Function Keys* and select the soft key **Enter**;
- 2) (Take the line keys as an example) Select a line key and then select **Enter**, and select **Group Pickup** in the type bar;
- 3) (Optional) Enter the information displayed on the screen in the label bar;
- 4) Enter the group pickup code in the value bar;
- 5) Select **Save**.

When there is an incoming call in the group, press the group pickup key to make the incoming call in the group be answered on your phone.

### 3.15 Speed Dial

You can use the speed dial to quickly dial the specified number.

#### Procedure

- 1) Navigate to *Menu > Features > Programmable Keys > Line Keys / Soft Keys / Function Keys*;
- 2) (Take the line keys as an example) Select a line key and then select **Enter**, and select **Speed Dial** in the type bar;
- 3) (Optional) Enter the information displayed on the screen in the label bar;
- 4) Enter the number in the value area;
- 5) The account bar is to select a account to make a call;
- 6) Select **Save**.

Press the speed dial key when the phone is idle, and the selected account will automatically dial the preset number.

### 3.16 Auto Redial

You can use the automatic redial feature when the called party does not answer.

#### Note:

Not all servers support the auto redial feature. Please consult your administrator for further information.

#### Procedure

- 1) Navigate to *Menu > Features > Auto Redial*;
- 2) Select enable in the active bar; fill in the time in the interval area; fill in the number of redial in the times bar;
- 3) Select **Save**.

After the phone call fails, an automatic redial countdown prompt will appear on the screen. You can press the OK key  to redial or wait for the countdown to finish.

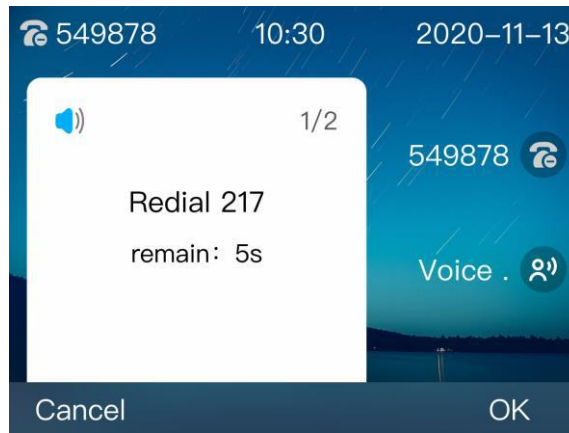



## 3.17 Intercom

You can make an intercom call to a contact. When receiving an intercom call, the phone will trigger an alert tone and automatically answer it in Speakerphone mode. The intercom feature is mainly used as the configuration of the receiver.

### Procedure

- 1) Navigate to *Menu > Features > Intercom*;
- 2) Select **Enable** in the active bar;
- 3) (Optional) Select **Enable** in the mute bar;
- 4) Select **Save**.

If the intercom mute is enabled on the phone, that is, the automatically answered intercom call is in the mute, the mute icon  is displayed on the screen. You must press the Mute key  to cancel.

When intercom supported by the server, you need to dial the code of the intercom feature + the extension number of the other party to initiate an intercom call. Take a 3CX server as an example: dial \*998100, where \*998 is the intercom code, and 100 is the extension number. For the codes of the intercom feature of other servers, please refer to the configuration guide documents of the servers.

## 3.18 Hot Desking

You can press the Hot Desking key to clear the registration information of all accounts on the phone when the phone is idle. Then register the account you want to. Through this function, more users can share this phone at different periods. Especially suitable for some public places.

**Note:** Not all servers support Hot Desking, please consult your administrator for further information.

**Procedure**

- 1) Navigate to *Menu > Features > Programmable Keys > Line Keys / Soft Keys / Function Keys*;
- 2) (Take the line keys as an example) Select a line key and then select **Enter**, and select **Hot Desking** in the type bar;
- 3) (Optional) Enter the information displayed on the screen in the label bar;
- 4) Select **Save**.

When you press the Hot Desking key, the phone screen will prompt "Whether to clear all account configurations", select Clear to enter the account configuration. For further information, please refer to *Menu > Settings > Advanced Settings > Account*.

### 3.19 XML Browser

The XML browser allows users to deploy custom services on the server. Users can quickly access it using the XML browser key. This feature requires pre-configuration of custom services on the server, such as news, weather reports, and inventory information. These informations will be received from the server and displayed on the screen, and all information will be transmitted in the form of XML.

**Procedure**

- 1) Navigate to *Menu > Features > Programmable Keys > Line Keys / Soft Keys / Function Keys*;
- 2) (Take the line keys as an example) Select a line key and then select **Enter**, and select **XML browser** in the type bar;
- 3) (Optional) Enter the information displayed on the screen in the label bar;
- 4) Enter the source path of the XML file in the value field;
- 5) Select **Save**.

When the phone is idle, press the XML browser key to access the XML browser specified.

### 3.20 Call Recording

The device sends a SIP INFO message with the "Record: on/off" header to trigger the server to record the call. The call recording will be saved on a server that supports the recording feature.

- Note:**
- 1). Not all servers support the call recording feature, please consult your administrator for further information;
  - 2). Before recording calls, especially those involving analog

telephone, you must understand all the rules and restrictions governing call recording in your country;  
 3). Similarly, before recording, inform all the callers that you are recording and obtain their consent.

**Procedure**

- 1) Navigate to *Menu > Features > Programmable Keys > Line Keys*;
- 2) Select **Record** in the type bar;
- 3) (Optional) Enter the information displayed on the screen in the label bar.

Press the record key during a call. If recording successfully, the LCD screen displays the icon . Press the record key again to stop recording. The recording icon on the screen disappears, and the record key LED stops flashing.

Manage recording: (Take the 3cx professional as an example) In the 3CX management console, the recording feature can help you search, manage, download and delete call recordings, and you can set the amount of recording and the time for automatic cleaning of call recordings.

### 3.21 Keypad Lock

You can use the keypad lock to ensure that your phone is not used by unauthorized users, or avoid misuse. Once you lock the phone, anyone must enter the password to unlock the phone. You can choose the lock type: function key or all keys.

Keypad Lock	
Keypad Lock Type	Function Key <input type="button" value="v"/>
Keypad Unlock PIN	..... (0~15)
Keypad Lock Timeout	0 (0~3600s)

**Function keys:** The function keys are locked. The line key, information key, soft key, navigation key, redial key, mute key, volume key, hold key, transfer key, speakerphone key, and headset key must be unlocked before they can be used.

**All keys:** All keys are locked. Until the PIN code prompt appears, the keyboard can be used.

The keypad lock function can only be configured through the web system.

Log in to the Web with the administrator account **Admin** (password: admin) and navigate to *Phone > Keys > Keypad Lock*. Select the type of keypad to be locked, set a password in the Keypad Unlock PIN field, and the Keypad Lock Timeout is used to set the delay time when not operating.

When the keypad lock is enabled, the lock icon  will be displayed on the screen of the phone. Anyone needs to enter a password to unlock the keyboard. If the password is wrong, a prompt "Wrong password!" will be displayed.



## 3.22 BLF

The line can be monitored with the BLF key. The status of the LED indicator of the BLF key is as follows:

LED indicator	description
Solid green	The monitored line is idle.
Solid red	The monitored line is dialing. The monitored line is talking.
Fast- flashing red	The monitored line receives an incoming call
Off	The monitored line does not exist.

Our phone supports three types of BLF: BLF/New Call; BLF/BXFER; BLF/AXFER.

**BLF/New Call:** This type is when the monitored line is idle, pressing the BLF key will make a new call to the monitored line.

**BLF/BXFER:** This type is to blindly transfer the current call to the monitored line when the line is idle.

**BLF/AXFER:** This type is to attended transfer the current call to the monitored line when the line is idle.

### 3.22.1 Setting a BLF Key

The line key can be set to BLF key to monitor the line status.

**Procedure**

- 1) Navigate to *Menu > Features > Programmable Keys > Line Keys*;
- 2) Select the type of BLF in the type bar: BLF/New Call; BLF/BXFER; BLF/AXFER;
- 3) (Optional) Enter the information displayed on the screen in the label bar;
- 4) Enter the number to be monitored in the value bar.
- 5) (Optional) Select the account used for answering in the account bar;
- 6) (Optional) Enter the extension code in the extension bar.
- 7) Select Save.

After the BLF key is successfully configured, the server will notify the phone through a NOTIFY message after the status of the monitored line changes.

### 3.22.2 Picking Up a Call by BLF Key

If you configure the pickup account and pickup code of the BLF key, when the monitored line receives an incoming call, you can answer the incoming call on your phone, avoiding missing important calls.

**Procedure**

- 1) When the monitored line receives a call;
- 2) If BLF pickup is enabled, the display as follows;

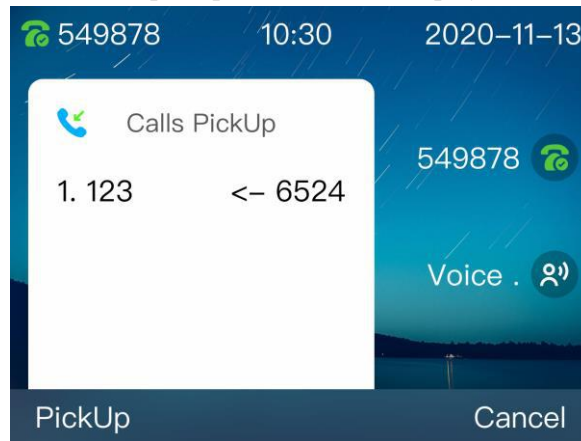

- 3) Select the Pickup, the phone can pickup calls from the monitored line.

### 3.22.3 Blind Transfer a Call by BLF Key

If the type is BLF/BXFER for BLF key. Then the current call can be blind transfer when the monitored line is idle; and the blind transfer is not performed when the monitored line is not idle.

**Procedure**

- 1) Answer the incoming call;
- 2) If the phone needs to transfer the call to the monitored line, first check whether the monitored line is free;
- 3) Press the **BLF** key to blind transfer;
- 4) The monitored line can continue to talk.

### 3.22.4 Attended Transfer a Call by BLF Key

If the type is BLF/AXFER for BLF key. Then the current call can be attended transfer when the monitored line is idle; and the attended transfer is not performed when the monitored line is not idle.

**Procedure**

- 1) Answer the incoming call;
- 2) If the phone needs to transfer the call to the monitored line, first check whether the monitored line is free;
- 3) Press the **BLF** key to attended transfer;

- 4) The monitored line can continue to talk.

### 3.23 BLF List

You can set the line key to be a BLF list to monitor a group of users managed by the system administrator.

**Procedure**

- 1) Navigate to *Menu > Features > Programmable Keys > Line Keys*;
- 2) Select the **BLF** list in the type bar;
- 3) (Optional) Enter the information displayed on the screen in the label bar;
- 4) (Optional) Select the account used for pickup in the account bar;
- 5) Select Save.

When the monitored line receives the call, the phone can answer the call by pressing the BLF list

**Note:** Not all servers support the BLF list. Please consult your system administrator for further information.

### 3.24 Automatic Call Distribution (ACD)

The ACD feature is often used in customer service centers, such as call centers. The ACD system can handle a large number of incoming calls. These calls do not need to pick up by agents, but they need to be handled or helped in proper way as soon as possible. The ACD feature is that the ACD system automatically allocates incoming calls to users who log in to the ACD system according to specific rules and strategies. ACD is disabled on the phone by default. You need to configure the line key to be an ACD so that the phone can log in to the ACD system and process the calls assigned by the system.

**Procedure**

- 1) Navigate to *Menu > Features > Programmable Keys > Line Keys*;
- 2) Select ACD in the type area;
- 3) (Optional) Enter the information displayed on the screen in the label bar;
- 4) Select the account used to log in to the ACD system in the account bar;
- 5) Select Save.

Configuration is completed, you can press the ACD key to log in to the ACD system to answer the call assigned to you.

### 3.25 Call Return

You can make the last call through the call return key.

**Procedure**

- 1) Navigate to *Menu > Features > Programmable Keys > Line Keys*;
- 2) Select call return in the type bar;
- 3) (Optional) Enter the information displayed on the screen in the label bar;
- 4) Select Save.

After the call return key is configured, press the call return key on the phone to automatically dial the last call.

## 3.26 Messages

The phone provides voice messages and text message communication methods. The text message supports sending new messages, receiving messages in the inbox, saving the sending messages in the outbox, and saving the editing information in the draft box. The messages that have been sent are saved. The voice message supports the configuration of different voice mailbox numbers for different accounts, the default is: \*170\*2#; and the voice message on the server can be obtained through subscription messages.

**Note:** Not all servers support the voice message. Please consult your system administrator for further information.

### 3.26.1 Text Message

Text messages can be stored in the inbox, sent messages, outbox, and draft box, each of which can store 100 text messages. If the number of text messages exceeds, the phone will delete the farthest text message.

#### Reading a text message

You can read text messages through the inbox.

**Procedure**

- 1) Navigate to *Menu > Message > Text Message > Inbox*;
- 2) Select the text message you want to view, and then select Enter.

**Note:** When the screen prompts you to receive a new text message, you can press the View soft key to read it.

#### Sending a text message

**Procedure**

- 1) Navigate to *Menu > Message > Text Message > New Message*;
- 2) Edit messages;
- 3) Select **Send** and fill in the number in the To bar;
- 4) Select **Send**.

#### Replying a text message

You can reply a text message after you have read it.

**Procedure**

- 1) Navigate to *Menu > Message > Text Message > Inbox*;
- 2) Select the text message you want to view, and then select Enter;
- 3) Select **Reply** soft key;
- 4) Edit the content of the text message;
- 5) Select **Send** and enter the number;
- 6) Select **Send** again.

**Deleting a text message**

You can delete the message you have read.

**Procedure**

- 1) Navigate to *Menu > Message > Text Message > Inbox (Sent Message, Outbox or Draft)*;
- 2) Select the message to be deleted;
- 3) (Optional) In step 2, you can select to **Enter**. When the message is confirmed to be deleted, select **Delete** to delete the message;
- 4) Select **Delete** to enter the delete option;
- 5) Select **Delete Single** or **Delete All**.

## 3.26.2 Voice Message

With the voice mail function, you can leave a voice message to someone or listen to your voice mail on your phone (not all servers support this function).

**Setting the voice message code**

Before viewing or listening to your voice message, you need to set the voice mail access code in advance (the code default: \*170\*2#).

**Procedure**

- 1) Navigate to *Menu > Message > Voice Message Setting*;
- 2) Select the account and set the voice code of each account;
- 3) Select **Save**.

**voice message**

When the called number is busy or not answering, you can leave a message to the contact.

**Procedure**

- 1) Leave a message for someone according to the voice prompt;
- 2) Follow the voice prompts to save the message or hang up the call.

**Listening to voice message**

You can view and listen to voice messages on the phone.

**Procedure**

- 1) Navigate to *Menu > Message > Voice Message > Voice Message view*;
- 2) The phone will list the message of all accounts;

- 3) Select an account with new messages;
- 4) Select **Connection**;
- 5) The phone will connect to the voice server by access code;
- 6) Follow the voice prompts to complete the message listening.

**Note:**

When the screen show you to receive a new message, you can press the View soft key to listen to the new voice message.

---

# 4 Settings

---

## 4.1 Basic settings

This part mainly guides users how to complete the settings of related functions and features of the phone through the interactive interface, which is convenient for users to customize services.

You can complete the basic configuration of the phone through *Menu > Settings > Basic Settings*.

### 4.1.1 Language

The phone provides you with multi-language support, you can change the language through the following methods:

**a) Selecting the initial language after resetting to factory**

After the administrator reset to factory of your phone, the initial language selection will be displayed on the screen. At this time, select the language you need and click the OK key . The phone will use the language you selected.

**b) Changing language through language setting**



Navigate to *Menu > Settings > Basic Settings > Language*, select the language and select **Save**.

## 4.1.2 Date & Time

The IP phone displays the time and date in the idle. You can set the time and date to be updated automatically from the SNTP server, or you can set the time and date manually.

### To configure the SNTP settings via phone user interface:

#### Procedure

- 1) Navigate to *Menu > Settings > Basic Settings > Date & Time > SNTP Settings*;
- 2) Press the left  /  right key or the **Switch** soft key to select the time zone suitable for your area. The default time zone is "+8 China (Beijing)";
- 3) Enter the domain name or IP address of the NTP server in the primary server and secondary server respectively;
- 4) (Optional) The daylight save time automatic mode is enabled by default; if you don't need it, you can choose to disable it.
- 5) Press the **Save** soft key to save the setting.





### To configure the time and date manually via phone user interface:

#### Procedure

- 1) Navigate to *Menu > Settings > Basic Settings > Date & Time > Manual Settings*;
- 2) Enter the date and time;
- 3) Press the **Save** soft key to save the settings, and the time and date displayed on the phone screen will be changed.

### To configure the date and time format via phone user interface:

#### Procedure

- 1) Navigate to *Menu > Settings > Basic Settings > Date & Time > Format Settings*;
- 2) Press the left  /  right key or the **Switch** soft key to select the time format (12-hour system or 24-hour system);
- 3) Press the left  /  right key or the **Switch** soft key to select the date format;
- 4) Press the **Save** soft key to save the setting.

The date displayed on the screen will vary depending on the date format. There are six date formats on the phone is displayed as follows:



Data Format	Example(2018/12/24/Mon)
YYYY-MM-DD	2018-12-24
YYYY/MM/DD	2018/12/24

DD-MM-YYYY	24-12-2018
DD/MM/YYYY	24/12/2018
WW-DD-MM	Mon 24 Dec
WW-MM-DD	Mon Dec 24

**Note:** When 'Display Mode Setting' is 'Enabled', the time and date displayed on the LCD screen will change accordingly.

#### To configure the display mode via phone user interface:

##### Procedure



- 1) Navigate to **Menu >Settings > Basic Setting >Date & Time >Display Mode Setting.**
- 2) Press Left  /  Right key, or the **Switch** soft key to select the desired display mode (Disabled/ Day/ Date/ Day Date) from the Display Mode field.
- 3) Press the **Save** soft key to accept the change or the Back soft key to cancel.

### 4.1.3 Ring Tones

The ring tone refers to incoming ring tone, which reminds the user that there is an incoming call. The ring tone of IP phone C62U/C62UP can be set to distinguish from other phones' ring tones; at the same time, the IP phone C62U/C62UP also supports setting specific incoming ring tone for different contacts.

#### To configure the ring tone via the phone user interface:

##### Procedure



- 1) Navigate to **Menu ->Settings ->Basic Setting ->Ring Tones;**
- 2) Press the Up  /  Down key to select the desired ring tone.
- 3) Press the **Save** soft key to accept the change or the **Back** soft key to cancel.

### 4.1.4 Phone Volume

The Volume key can be used to adjust the volume of handset, speakerphone or headset during a call. The key can also be used to adjust the volume of ring tones when the phone is idle.

Adjust the volume via the phone interface, Press **Menu ->Settings ->Basic Setting ->Phone Volume.** In the Volume Setting interface, access the Handset Volume, Handfree Volume or Headset Volume, then press the + or - soft key or







Left  /  Right key to adjust the volume. Press the **Save** soft key to save the configuration or press the **Back** soft key to cancel.

### 4.1.5 Backlight

You can set the brightness (level) of the screen backlight and its duration.



#### Procedure

- 1) Navigate to *Menu > Settings > Basic Setting > Backlight*;
- 2) Press the Right  /  Left key to select a level for the backlight, and press the down key to set duration. Press the Right  /  Left key to select a value for duration.
- 3) Press the **Save** soft key.

### 4.1.6 Screensaver

When the phone is in standby for a period of time, the screen will automatically enter the screensaver. You can press any key to exit the screensaver, or you can set the screen saver time.

#### Procedure

- 1) Navigate to *Menu > Settings > Basic Settings > Screensaver*;
- 2) Press the left  /  right key or the **Switch** soft key to select the time;
- 3) Select **Save**.

## 4.2 Phone Book

The phone supports a variety of phone books to save contact information, including: local phone book, remote phone book, LDAP and Broad Soft phone book.



### 4.2.1 Local Phone Book

The Local Phone Book is used for storing the contacts names and number. The C62U/C62UP IP Phone can store up to 1000 entries contacts and 10 groups in your phone's local phone book. You can add, edit, delete, search, or call any contact from the Local Phone Book.

#### Adding groups to the Local Phone Book:



##### Procedure

- 1) Navigate to *Menu > Book*;
- 2) Select **Local Phone Book** and press the **OK** key  or the **Enter** soft key to enter the Local Group interface;
- 3) Press the **Add** soft key;

- 4) Enter the desired group name in the Group Name field. Press Left  /  Right key, or the **Switch** soft key to select the desired group ring tone from the Ring Tones field. If Auto is selected, this group will use the ring tone assigned;
- 5) Press the **Save** soft key to accept the change or the **Back** soft key to cancel.



#### Editing a group in the Local Phone Book:

##### Procedure

- 1) Navigate to *Menu > Book*;
- 2) Select **Local Phone Book** and press the **OK** key  or the **Enter** soft key to enter the Local Group interface.
- 3) Select the desired contact group.
- 4) Press the **Option** soft key and then select **Detail** from the display list.
- 5) Press Left  /  Right key, or the **Switch** soft key to select the desired group ring tone from the Ring Tones field. If Auto is selected, this group will use the ring tone assigned to the account.
- 6) Press the **Save** soft key to accept the change or the **Back** soft key to cancel.

#### Adding contact manually

##### Procedure

- 1) Navigate to **Menu > Book > Local phone book**;
- 2) Select the group (For example: contacts) and press the **OK** key  or the **Enter** soft key to enter the relevant group interface.
- 3) Press the **Add** soft key to enter the Add Contact interface.
- 4) Enter the name and the office, mobile or other numbers in the corresponding fields.
- 5) Press Left  /  Right key, or the **Switch** soft key to select the desired ringtone, group, account from the corresponding fields.
- 6) Press the **Save** soft key to accept the change or the **Back** soft key to cancel.

#### Adding contacts from All Calls History



##### Procedure

- 1) Press the **History** soft key and then select a history from the display list.
- 2) Press the **Option** soft key and then select **Add to Contacts** from the display list.
- 3) Press **OK** soft key or **OK** key  to enter the Add Contact interface.

- 4) Press the **Save** soft key to accept the change or the **Back** soft key to cancel.

### Searching Contacts

#### Procedure

- 1) Navigate to *Menu > Book*;
- 2) Select the **Local Phone Book**, Press the **OK** key  on the phone or the **Enter** soft key to enter the Local Phone Book.
- 3) Press the **Search** soft key to search contacts.
- 4) Input keywords such as name, any character of number or whole phone number, press the **Search** soft key or the **OK** key  to enter the Search Contacts interface.
- 5) The desired contact in the list of displayed results.

## 4.2.2 Blacklists

C62U/C62UP IP phone supports 100 blacklists. You can add, edit, delete, search or call a contact. Any call from the number in the blacklists will be rejected.

### Putting a number into Blacklist:

#### Procedure

- 1) When the IP phone is idle, press *Book > Blacklist > Add*.
- 2) Fill in the phone number;
- 3) Press the **Save** soft key.

## 4.2.3 Remote Phone Book

Access the remote phone book, add the contacts to the local phone book from the remote phone book or make calls from the remote phone book. 5 URLs of remote phone book is available to set.

### Configuring the remote phone book via Web interface:

#### Procedure

- 1) Navigate to *PhoneBook -> Remote Book*.
- 2) Input URL of phone book in Local Book URL field.
- 3) Input the phone book name in Local Book Name field.
- 4) Click the **Submit** key to submit.

### Accessing the remote phone book via phone interface:

#### Procedure

- 1) Navigate to *Book > Remote Phone Book*.
- 2) Select the relevant Remote Group and press the **Enter** soft key. The phone will load the remote group information, and the LCD will display the contacts of this remote group.





- 3) Press the **Back** soft key to unlink.

## 4.3 History Management

The call history list includes dialed calls, received calls, missed calls and forwarded calls and support 100 logs storage at most. You can check the history, make calls from the calls history and delete the calls history.

### Accessing the History via phone interface:

#### Procedure

- 1) Press the **History** soft key, the screen will display all the recent calls.
- 2) Press the Left  /  Right key to switch the lists of All Calls, Dialed Calls, Received Calls, Missed Calls and Forwarded Calls.
- 3) Press the Up  /  Down key to select the log.
- 4) Press the **Option** soft key and select the **Detail**. The screen will display the detailed information of this log; Press the **Dial** soft key, to make a call from the history; Press the **Option** soft key to add to contacts(Move to Blacklists ) from the history; Press the **Delete** soft key to delete calls log from the history; Press the **Option** soft key to select “Delete All” to delete all the call logs from the history.

## 4.4 Customizing your phone

### 4.4.1 Programmable Keys

#### Setting programmable keys via the phone interface

##### Procedure

- 1) Navigate to *Menu >Features >Programmable Keys*;
- 2) Select the programmable key you will set and press the **Enter** soft key;
- 3) Select key style in the type area;
- 4) Input suitable value in the label area;
- 5) (Optional) Select the relevant account in the account ID area;
- 6) (Optional) Input suitable value in Value area;
- 7) Select the **Save** soft key to save or the **Cancel** soft key to cancel.

### 4.4.2 SIP Account Management

You can register one SIP account or multiple accounts for your phone, but also can set one or two SIP servers for one account.

**Registering an account:****Procedure**

- 1) Navigate to *Menu > Settings > Advanced Settings (password: admin) > Account*;
- 2) Select the account you want to set and press the **Enter** soft key;
- 3) Select “Enable” in the active area;
- 4) Input the label, display name, register name, user name, password and SIP server separately;
- 5) Press the **Save** soft key to save or the **Back** soft key to cancel;
- 6) Repeat step 2 to 5 to finish all the account register.

**Disabling an Account****Procedure**

- 1) Navigate to *Menu > Settings > Advanced setting (password: admin) > Account*
- 2) Select the account you want to disable and press the **Enter** soft key.
- 3) Select “Disable” in the account active area.
- 4) Press the **Save** soft key to save or the **Back** soft key to cancel.



**Note:** Refer to the above steps for other SIP account registration.

## 4.5 Basic Network Settings

Through the Basic Network setting, you can set the IP Phones to get the IP address by three ways: DHCP, static IP and PPPoE, also can set the VLAN.

### 4.5.1 LAN Mode

**Setting the LAN mode****Procedure**



- 1) Navigate to *Menu > Settings > Advanced Settings (password: admin) > Network > LAN Port > LAN Mode*;
- 2) Press the up  /  down keys to select the "IPv4" or "IPv6" ;
- 3) Press OK  to save.

**Note:** you need to reboot to take effect after modifying.

### 4.5.2 DHCP Mode

**Configuring the DHCP Mode:****Procedure**





- 1) Navigate to *Menu > Settings > Advanced Setting (password: admin) > Network > LAN Port > IPv4 / IPv6*;

- 2) Press the Up  /  Down key on the phone keyboard to select DHCP (default is DHCP).
- 3) Press the **Enter** soft key or the OK key  to enter the DHCP switch interface, it will auto return to last interface after seconds.

### 4.5.3 Static IP Mode

#### Configuring the Static IP Mode:





##### Procedure

- 1) Navigate to **Menu > Settings > Advanced Setting (password: admin) > Network > LAN Port > IPv4 / IPv6;**
- 2) In the LAN Port interface, press the Up  /  Down key to select Static IP, then Press the OK key  or the Enter soft key to enter Static IP Setting interface;
- 3) Input the IP address, Subnet mask, Gateway, DNS 1 and DNS 2 in the corresponding area.
- 4) Press the OK key  or the Save soft key to save.

### 4.5.4 PPPoE Mode

#### Configuring the PPPOE Mode:





##### Procedure

- 1) Navigate to **Menu > Settings > Advanced Setting(password: admin) > Network > LAN Port > IPv4 / IPv6;**
- 2) In the LAN Port interface, press the Up  /  Down key to select PPPoE, then Press the OK key  or the Enter soft key to enter PPPoE Setting interface;
- 3) Enter the username and password in the corresponding fields;
- 4) Press the OK key  or the **Save** soft key to save.

### 4.5.5 Configuring VLAN

#### Enabling the LAN Port:





##### Procedure

- 1) Navigate to **Menu > Settings > Advanced Setting (password: admin) > Network > VLAN Port > LAN Port.**
- 2) Press the Left  /  Right key or Switch soft key to select **Enable** in the LAN Port activation field.
- 3) Press the Up  /  Down key to enter the VID and Priority in the corresponding fields.

- 4) Press the **OK** key  or **Save** key to reboot (Setting will take effect after reboot, if cancel the reboot, the settings will be saved but not take effect).

#### Enabling the PC Port:



##### Procedure

- 1) Navigate to *Menu > Settings > Advanced Setting (password: admin) > Network > VLAN Port > PC Port;*
- 2) Press the Left  /  Right key or Switch soft key to select **Enable** in the PC Port activation field.
- 3) Press the Up  /  Down key to enter the VID and Priority in the corresponding fields.
- 4) Press the **OK** key  or **Save** key to reboot (Setting will take effect after reboot, if cancel the reboot, the settings will be saved but not take effect) .

## 4.6 Web Server

#### Configuring the Web Server:

##### Procedure

- 1) Navigate to *Menu > Settings > Advanced Setting (password: admin) > Web Server;*
- 2) Press the Left  /  Right key or Switch soft key to select **Enable** in the Web Server activation field.
- 3) Press the **Save** soft key or the OK key  to save or the **Back** soft key to cancel.

## 4.7 Reset to Factory

#### Reset to Factory :

##### Procedure

- 1) Navigate to *Menu > Settings > Advanced Setting (password: admin);*
- 2) Press the **OK** key  or the **Enter** soft key to access the reset to factory.

## 4.8 Password Setting

This feature is used to set the password for advanced settings

**Procedure**

- 1) Navigate to *Menu > Settings > Advanced Settings (password: admin) > Password Settings;*
- 2) Enter the current password, new password and confirm password in the corresponding area;
- 3) Press **OK**  to set.

## 4.9 Auto Provision

**Setting automatic update version for phone:**



**Procedure**

- 1) Navigate to *Menu > Settings > Advanced Settings (password: admin) > Auto Provision;*
- 2) Enter the URL and set the mode, etc.;
- 3) Press **OK**  to save.

## 4.10 Reboot

**Restart the phone:**

**Procedure**

- 1) Navigate to *Menu > Settings > Advanced Setting (password: admin);*
- 2) Press the Up  /  Down key to select **Reboot;**
- 3) Press the **OK** key  or the **Enter** soft key to reboot.



---

# 5 Web Platform

---

## 5.1 Login & Logout

The web system of the C62U/C62UP IP phone is used for users or administrators to check or modify the phone parameter.

**Note:** The web interface of C62U/C62UP and C62G/C62GP is the same, this document uses the web interface of C62G/C62GP.

### Checking the IP address of the phone and log in to the web system:

- 1) Press OK key  to view the IP address of the phone.
- 2) Input the IP address of the phone (such as http://172.31.2.167) in the browser address box and press Enter.
- 3) If successfully connected to the IP phone, it will enter the login page. On this page, enter the correct username and password. By default, username and password are as below:

**User Name: admin**

**Password: admin**

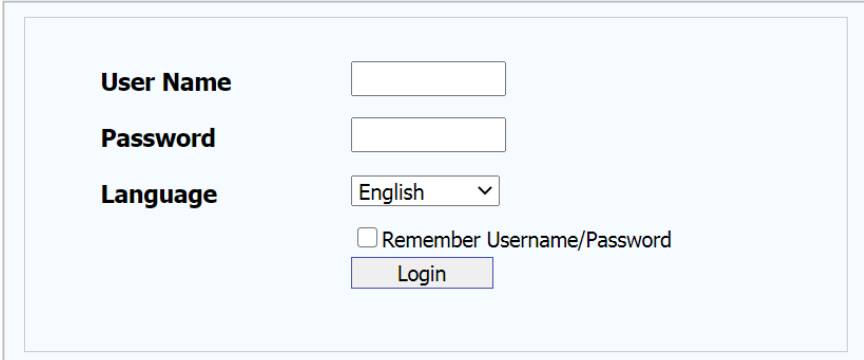

<b>User Name</b>	<input type="text"/>
<b>Password</b>	<input type="password"/>
<b>Language</b>	English <input type="button" value="v"/>
	<input type="checkbox"/> Remember Username/Password
	<input type="button" value="Login"/>

### Log out:

You can log out of the web system by clicking log out in the upper right corner of the window.

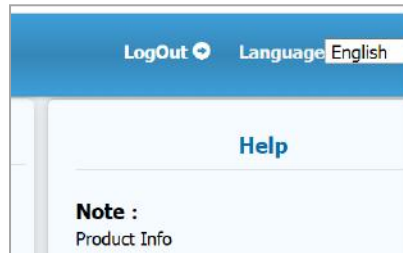

## 5.2 Status

### 5.2.1 Status->Basic

After successfully log in, it will automatically locate to Status->Basic as shown below:

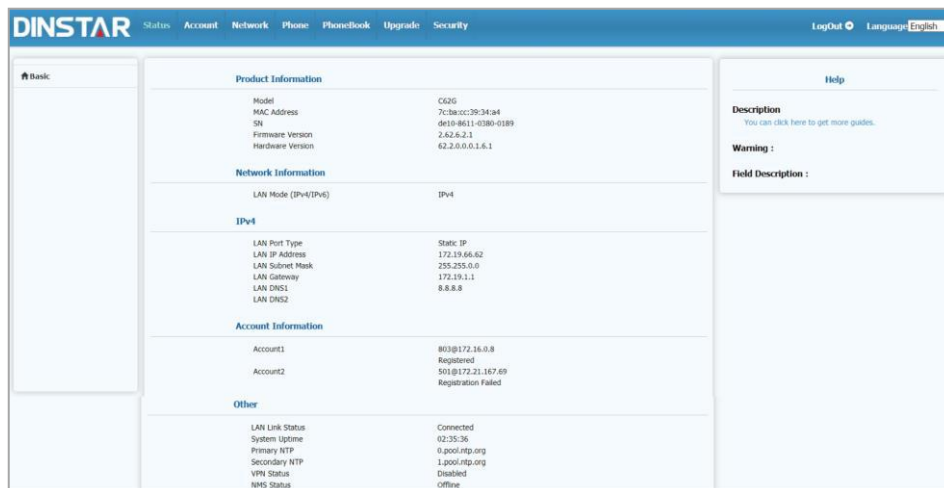

Sections	Description
<b>Product Information</b>	It provides the device's information such as Model name, MAC address (IP device's physical address), Firmware version and Hardware version.
<b>Network Information</b>	Show you the network mode (LAN port) of the device.
<b>IPv4</b>	It provides the information of the LAN port IPv4 type (may be DHCP/static/PPPoE), IP address, subnet mask, gateway, preferred DNS server and alternative DNS server.
<b>IPv6</b>	It provides the information of the LAN port IPv6 type (may be DHCP/static/PPPoE), IP address, gateway, preferred DNS server and alternative DNS server.
<b>Account Information</b>	It provides the device's Account information and Registration status (account username, registered server's

Sections	Description
	address, and Register result).
Others	Show you LAN port connection status, running time, primary NTP server, secondary NTP server (NTP server is used to automatically synchronize time from the Internet), VPN status and NMS status.

## 5.3 Account

### 5.3.1 Account->Basic

The screenshot shows the DINSTAR web interface for configuring a SIP account. The navigation menu includes Status, Account, Network, Phone, PhoneBook, Upgrade, and Security. The left sidebar has options for Basic, Advanced, and Codecs. The main content area is titled 'SIP Account' and contains the following configuration sections:

- SIP Account:**
  - Status: Registration Failed
  - Account: Account1: 6002
  - Active: Enabled
  - Display Label: 6002
  - Display Name: 6002
  - Register Name: 6002
  - Username: 6002
  - Password: \*\*\*\*\*
- SIP Server 1:**
  - Server IP: 172.28.20.120
  - Port: 5060
  - Registration Expires: 1700 (30~65535s)
- SIP Server 2:**
  - Server IP: [Empty]
  - Port: 5060
  - Registration Expires: 1800 (30~65535s)
- Outbound Proxy Server:**
  - Active: Disabled
  - Server IP: [Empty]
  - Port: 5060
  - Backup Server IP: [Empty]
  - Port: 5060
- Transport Type:**
  - Transport Type: UDP
- NAT:**
  - NAT: Disabled
  - Stun Server Address: [Empty]
  - Port: 3478
- VPN:**
  - VPN Preferred: Enabled

Buttons for 'Submit' and 'Cancel' are located at the bottom of the configuration area.

Sections	Description
SIP Account	<p>For the specified account settings.</p> <ul style="list-style-type: none"> <li>• Status: To display register result.</li> <li>• Account: SIP account</li> <li>• Active: To enable or disable SIP account</li> <li>• Display Label: Which is displayed on the phone's</li> </ul>

Sections	Description
	<ul style="list-style-type: none"> <li>• Display Name: Which is sent to the other call party for display.</li> <li>• Register Name: Allocated by SIP server provider, used for authentication.</li> <li>• Username: the extension name assigned by the SIP server.</li> <li>• Password: Used for authorization.</li> </ul>
<b>SIP Server 1</b>	<p>For the primary SIP server settings.</p> <ul style="list-style-type: none"> <li>• Server IP: SIP server address, it could be an URL or IP address.</li> <li>• Registration Expires: The registration will expire after Registration period, the IP phone will re-register automatically within registration period.</li> </ul>
<b>SIP Server 2</b>	<p>For the secondary SIP server settings.</p> <p>This is for redundancy, if registering to Primary SIP server fails, the IP phone will go to Secondary SIP server for registering.</p> <p><b>Note:</b> Secondary SIP server is used for redundancy, it can be left blank if there is not redundancy SIP server in user's environment.</p>
<b>Outbound Proxy Server</b>	<p>For the Outbound Proxy server settings. An outbound proxy server is used to receive all initiating request messages and route them to the designated SIP server.</p> <p><b>Note:</b> If configured, all SIP request messages from the IP phone will be sent to the outbound proxy server forcefully.</p>
<b>Transport Type</b>	<p>It configures Transport type for SIP message</p> <ul style="list-style-type: none"> <li>• UDP: UDP is an unreliable but very efficient transport layer protocol.</li> <li>• TCP: Reliable but less-efficient transport layer protocol.</li> <li>• TLS: Secured and Reliable transport layer protocol.</li> <li>• DNS-SRV: A DNS RR for specifying the location of services.</li> </ul>
<b>NAT</b>	<p>NAT (Net Address Translator) settings.</p> <ul style="list-style-type: none"> <li>• STUN: Short for Simple Traversal of UDP over NATS, a</li> </ul>

---

Sections	Description
	<p>solution to solve NAT issues.</p> <p><b>Note:</b> By default, NAT is disabled.</p>
VPN	<p>For a specific account configure VPN options.</p> <ul style="list-style-type: none"><li>• VPN preferred: If enabled, the designated account will preferentially use the VPN address for communication. If disabled, the specified account uses the local address to communicate.</li></ul> <p><b>Note:</b> By default, VPN priority is enabled.</p>

## 5.3.2 Account->Advanced

**DINSTAR**
Status Account Network Phone PhoneBook Upgrade Security

Basic

Advanced

Codecs

### SIP Account

Account:

#### Subscribe

MWI Subscribe:  (120~65535s)

MWI Subscribe Period:  (120~65535s)

Voice Mail Number:

BLF Expire:  (120~65535s)

ACD Expire:  (120~65535s)

#### DTMF

Type:

DTMF Info Type:

DTMF Payload:  (96~127)

#### Call

Min Local SIP Port:  (1024~65535)

Max Local SIP Port:  (1024~65535)

Use New SIP Port When Registration Fail:

Call without Registration:

Caller ID Header:

Auto Answer:

Ringtones:

PRACK:

Invite with user=phone:

Send MAC Info:

PTime:

Anonymous Call:

Anonymous Call Rejection:

Privacy Number:

Escape non-ASCII characters:

Missed Call Display on LCD:

Trust SIP Server Only:

TLS version:

#### Hotline

Active:

Number:

Delay Time:  (0~5s)

#### Music Server

Active:  截图(Alt + A)

Music Server:

#### Session Timer

Active:

Session Expire:  (90~7200s)

Session Refresher:

#### BLF List

BLF List URI:

BLF List Pickup Code:

BLF List Barge in Code:

#### Broadsoft

AoC:

#### Encryption

SRTP:

<b>NAT</b>	
UDP Keep Alive Messages	Enabled <input type="text"/>
UDP Alive Msg Interval	30 <input type="text"/> (5~60s)
RPort	Disabled <input type="text"/>
<b>Conference</b>	
Type	Local <input type="text"/>
Conference URI	<input type="text"/>
<b>User-Agent</b>	
User-Agent	<input type="text"/>
<b>Keep Alive</b>	
Active	Disabled <input type="text"/>
Keep Alive Interval	15 <input type="text"/> (5~3600s)
Keep Alive Error Code	<input type="text"/> (100~699)
<b>Others</b>	
Sync Time from SIP Server	Disabled <input type="text"/>
Use IPv6 Stateless Address	Enabled <input type="text"/>
SIP Registration Retry Timer	3 <input type="text"/> (0~1800s)
<input type="button" value="Submit"/> <input type="button" value="Cancel"/>	

Sections	Description
SIP Account	Show you current Account settings or to select which account to display.
Subscribe	<p>It configures MWI, BLF, ACD subscription features.</p> <ul style="list-style-type: none"> <li>• MWI Subscribe: Message Waiting Indicator which is used to indicate whether there is unread new voice message. Enable or disable a subscription for MWI service.</li> <li>• MWI Subscribe Period: the IP phone sends a refresh SUBSCRIBE request before initial SUBSCRIBE expiration.</li> <li>• Voice Mail Number: The IP phone will subscribe to the voice mail number for MWI service using Subscribe MWI to Voice Mail.</li> <li>• BLF Expire: BLF is short for Busy Lamp Field which is used to monitor the designated extension status. Configures the period (in seconds) of the BLF subscription for each account.</li> <li>• ACD Expire: Automatic Call Distribution is often used in offices for customer service, such as call center. The setting here is to negotiate with the server about expire time of ACD subscription. Configures the period (in seconds) of ACD subscription for each account.</li> </ul>
DTMF	<p>It configures DTMF feature.</p> <ul style="list-style-type: none"> <li>• Type: Support Inband, Info, RFC2833 or their combinations.</li> </ul>

Sections	Description
	<ul style="list-style-type: none"> <li>• DTMF Info Type: Only available when DTMF Type is Info.</li> <li>• DTMF Payload: To configure payload type for DTMF.</li> </ul> <p><b>Note:</b> By default, DTMF type is RFC2833 which is the standard. Type Inband uses inband frequency to indicate DTMF tone which is most used to be compatible with traditional telephone server. Type Info use SIP Info message to indicate DTMF message.</p>
Call	<p>It configures call-related features.</p> <ul style="list-style-type: none"> <li>• Max Local SIP Port: To configure maximum local sip port for designated account.</li> <li>• Min Local SIP Port: To configure minimum local sip port for designated account.</li> <li>• Use New SIP Port When Registration Fail: After enabling this function, the SIP port will be reassigned when the registration fails.</li> <li>• Call without Registration: When this function is enabled, it is allowed to make outgoing calls without registering an account.</li> <li>• Caller ID Header: To configure which Caller ID format to fetch for displaying on Phone UI.</li> <li>• Auto Answer: If enabled, IP phone will be auto-answered when there is an incoming call for designated account.</li> <li>• Ringtones: Choose the ringtone for each account.</li> <li>• PRACK: 100% reliability for all provisional message, this means it will send ACK every time the IP phone receive a provisional SIP message from SIP server.</li> <li>• Invite with user=phone: If enabled, IP phone will send user=phone within SIP message.</li> <li>• Send MAC Info: If enabled, the IP phone will bring the MAC information in the SIP registration list;</li> <li>• PTime: Interval time between two consecutive RTP packets.</li> <li>• Anonymous Call: If enabled, all outgoing call for the designated account will be anonymous number.</li> <li>• Anonymous Call Rejection: If enabled, all incoming anonym-out call for the designated account will be rejected.</li> </ul>



Sections	Description
	<ul style="list-style-type: none"> <li>• Privacy Number: Configure the privacy value of the IP phone in the SIP 180 message.</li> <li>• Escape non- ASCII characters: To transfer the symbol to Ascii character.</li> <li>• Missed Call Display on LCD: To display the miss call log.</li> <li>• Trust SIP Server Only: When enabled, only receive calls from SIP server.</li> <li>• TLS Version: Choose TLS version</li> </ul>
<b>Hotline</b>	<p>The hotline allows users to automatically dial a defined number after hearing a dial tone without dialing any number.</p> <p>Function on: Enable or disable the hotline function.</p> <p>Number: Set the defined hotline number.</p> <p>Delay: Set the interval for automatic outgoing calls after hearing the dial tone.</p>
<b>Music Server Address</b>	<p>It configures third-party MOH (music-on-hold) server.</p> <ul style="list-style-type: none"> <li>• Active: To enable or disable this MOH server,If enabled, the IP phone will play MOH from configured server.</li> <li>• Music Server: To configure MOH server address.</li> </ul>
<b>Session Timer</b>	<p>Session timer settings.</p> <ul style="list-style-type: none"> <li>• Active: To enable or disable this feature, If enable, the ongoing call will be disconnected automatically once the session expired unless it's been refreshed by UAC or UAS.</li> <li>• Session Expire: Configure session expire time.</li> <li>• Session Refresher: To configure who should be response for refreshing a session.</li> </ul> <p><b>Note:</b> UAC means User Agent Client, here stands for IP phone. UAS means User Agent Server, here stands for SIP server.</p>
BLF List	<p>It configures BLF List URI address.</p> <ul style="list-style-type: none"> <li>• BLF List URI: BLF List is short for Busy Lamp Field List.</li> <li>• BLF List Pickup Code: To set the BLF pick up code.</li> <li>• BLF List Barge In Code: To set the BLF barge in code.</li> </ul>
Broadsoft	<p>It configures Broadsoft AOC feature.</p>

Sections	Description
	<ul style="list-style-type: none"> <li>AoC: A feature used to be accounting on Broadsoft platform.</li> </ul> <p><b>Note:</b> Please consult your administrator further information.</p>
<b>Encryption</b>	<p>It enables or disables SRTP feature.</p> <ul style="list-style-type: none"> <li>Voice Encryption (SRTP): If enabled, all audio signal(technically speaking its RTP streams) will be encrypted for more security.</li> </ul>
<b>NAT</b>	<p>NAT-related settings.</p> <ul style="list-style-type: none"> <li>UDP Keep Alive message: If enabled, IP phone will send UDP keep-alive message periodically to router to keep NAT port alive.</li> <li>UDP Alive Msg Interval: Keep alive message interval.</li> <li>Rport: Remote Port, if enabled, it will add Remote Port into outgoing SIP message for designated account.</li> </ul>
<b>Conference</b>	<p>To select Local or network conference.</p> <ul style="list-style-type: none"> <li>Type: To select desired conference type</li> <li>Conference URI: If network conference is selected, a network conference URI is needed.</li> </ul>
<b>User Agent</b>	<p>One can customize User Agent field in the SIP message. If user agent is set to specific value, user could see the information from PCAP. If user agent is not set by default, user could see the company name, model number and firmware version from PCAP.</p>
<b>Keep Alive</b>	<ul style="list-style-type: none"> <li>Active: When enabled, it will send an Option message to the server;</li> <li>Keep Alive Interval: The interval time between sending option messages;</li> <li>Keep Alive Error Code: A response code used to determine network failures.</li> </ul>
<b>Others</b>	<p>Other settings.</p> <ul style="list-style-type: none"> <li>Sync Time from SIP Server: If enabled, the IP phone will synchronize the phone time through the registered 200ok Date header (if the server supports the Date header).</li> </ul>

### 5.3.3 Account-> Audio Codecs

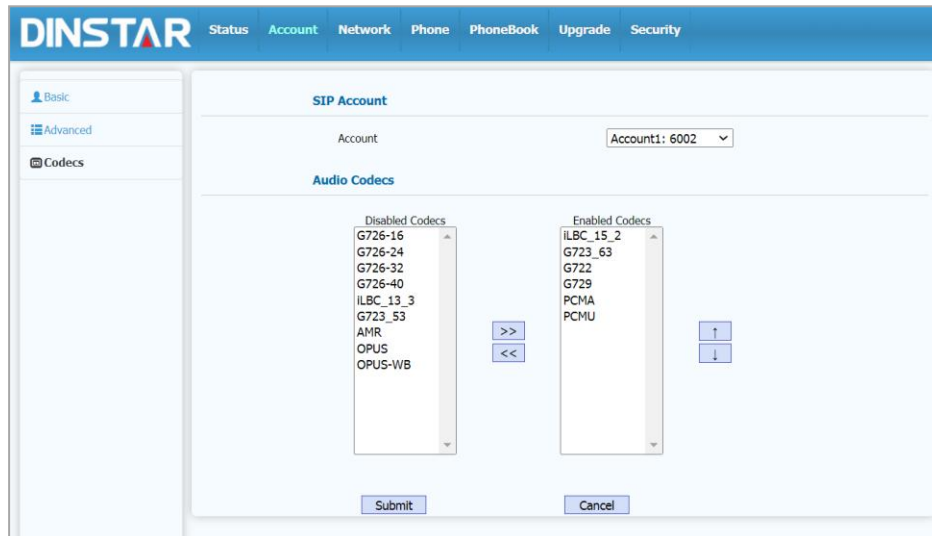

Sections	Description
<b>SIP Account</b>	Show you current Account settings or to select which account to display.
<b>Audio Codecs</b>	To display and configure available/unavailable codecs list. Codec means coder-decoder which is used to transfer analog signal to digital signal or vice versa. Familiar codecs are PCMU(G711U), PCMA(G711A), G722(wide-bandth codecs), G729, G723_53, G723_63, G726_16, G726_24, G726_32, G726_40.

## 5.4 Network

### 5.4.1 Network->Basic

The screenshot displays the Dinstar web interface for network configuration. The top navigation bar includes 'Status', 'Account', 'Network', 'Phone', 'PhoneBook', 'Upgrade', and 'Security'. The left sidebar lists various configuration options: Basic, Advanced, TR069, SNMP, NMS, VLAN&QoS, 802.1X, and Diagnosis. The main content area is titled 'LAN Port Mode' and contains several sections:

- LAN Port Mode:** A dropdown menu set to 'IPv4'.
- LAN Port IPv4:**
  - Radio buttons for 'DHCP' (selected) and 'Static IP'.
  - Fields for IP Address (172.19.151.103), Subnet Mask (255.255.0.0), and Default Gateway (172.19.1.1).
  - Radio buttons for 'Static DNS' (ON selected, OFF unselected).
  - Fields for LAN DNS1 (4.4.4.4) and LAN DNS2 (8.8.8.8).
- LAN Port IPv6:**
  - Radio buttons for 'DHCP' (selected) and 'Static IP'.
  - Fields for IP Address, Prefix Length, and Default Gateway.
  - Radio buttons for 'Static DNS' (OFF selected, ON unselected).
  - Fields for LAN DNS1 and LAN DNS2.
- LAN PPPoE:**
  - Radio buttons for 'PPPoE' (selected) and 'Static IP'.
  - Fields for Username and Password (masked with asterisks).
- PC Port:**
  - Radio buttons for 'As Bridge' (selected) and 'As Router'.
- Speed and Duplex:**
  - Dropdown menus for 'LAN port' and 'PC port', both set to 'Auto Negotiation'.

At the bottom of the form are 'Submit' and 'Cancel' buttons.

Sections	Description
LAN Port Mode	It configures LAN port mode, IPv4, IPv6, IPv4&IPv6 are optional.
LAN Port IPv4	It configures the LAN port IPv4: <ul style="list-style-type: none"> <li>DHCP: If enabled, the IP phone will automatically obtain the IP address, subnet mask, default gateway and DNS server address from the DHCP server.</li> <li>Static IP: If enabled, you must manually set the IP address, subnet mask, default gateway and DNS server.</li> </ul>
LAN Port IPv6	It configures the LAN port IPv6: <ul style="list-style-type: none"> <li>DHCP: If enabled, the IP phone will automatically obtain</li> </ul>

Sections	Description
	<p>the IP address, prefix length, default gateway and DNS server addresses from the DHCP server.</p> <ul style="list-style-type: none"> <li>Static IP: If enabled, you must manually set the IP address, prefix length, default gateway and DNS server.</li> </ul>
LAN PPPoE	<p>LAN PPPoE settings:</p> <ul style="list-style-type: none"> <li>PPPoE: Use PPPoE username &amp; password to connect to PPPoE server.</li> </ul>
PC Port	<p>PC Port settings.</p> <ul style="list-style-type: none"> <li>As Bridge: If selected, IP phone will act as a switch to route all incoming and outgoing packets from PC port.</li> </ul>
Speed and Duplex	Set the network full-duplex, half-duplex and speed

## 5.4.2 Network-Advanced

Sections	Description
LLDP	<p>It configures LLDP feature.</p> <ul style="list-style-type: none"> <li>Active: To enable or disable LLDP feature.</li> <li>Packet Interval: To configure the interval for LLDP admin message.</li> </ul> <p><b>Note:</b> LLDP stands for Link Layer Discovery Protocol, it is</p>

	used to exchange device information between any two directly-connected devices. LLDP is often used to configure Voice VLAN automatically for IP phone.
<b>Local RTP</b>	Local RTP settings. <ul style="list-style-type: none"> <li>Max RTP Port: Determine the maximum port that RTP stream can use.</li> <li>Min RTP Port: Determine the minimum port that RTP stream can use.</li> </ul>
<b>DHCP Option</b>	Option 12 (Hostname): Custom phone host name (if blank, the host name is phone model).
<b>SSH</b>	To display and configure SSH settings: <ul style="list-style-type: none"> <li>Active : enable or disable this function.</li> </ul>
<b>OpenVPN</b>	VPN settings. <ul style="list-style-type: none"> <li>Active: To enable or disable VPN feature.</li> <li>Upload: To upload VPN client configuration file which is used to connect to VPN server.</li> </ul> <p><b>Note:</b> For now, IP phone can only support OpenVPN.</p>

### 5.4.3 Network ->TR069

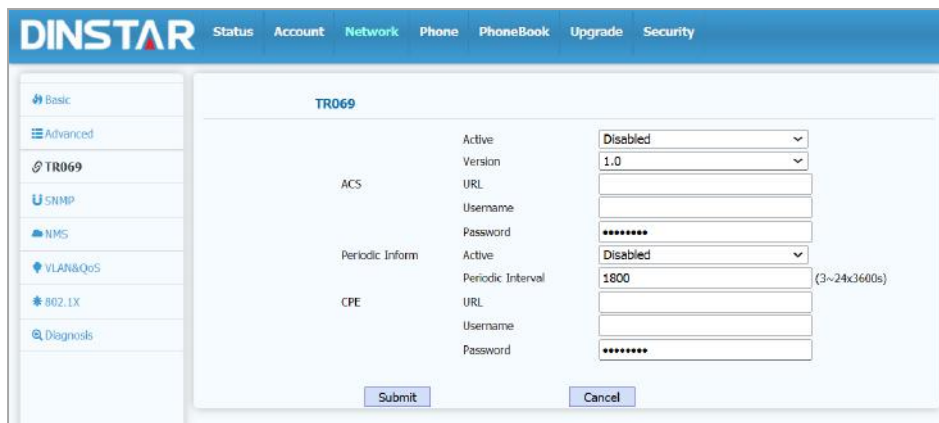

Sections	Description
TR069	TR069 settings. <ul style="list-style-type: none"> <li>Active: To enable or disable TR069 feature.</li> <li>Version: To select supported TR069 version (version 1.0 or 1.1).</li> </ul>

	<ul style="list-style-type: none"> <li>• URL: To configure URL address for ACS.</li> <li>• User name: To configure username for ACS.</li> <li>• Password: To configure Password for ACS.</li> <li>• Periodic Inform: To enable periodically inform.</li> <li>• Periodic Interval: To configure interval for periodic inform.</li> <li>• CPE: CPE is short for Customer-premise equipment as client side devices.</li> <li>• URL: To configure URL address for CPE.</li> <li>• User name: To configure username for CPE.</li> <li>• Password: To configure Password for CPE.</li> </ul> <p><b>Note:</b> TR-069(Technical Report 069) is a technical specification entitled CPE WAN Management Protocol (CWMP). It defines an application layer protocol for remote management of end-user devices.</p>
--	---

### 5.4.4 Network ->SNMP

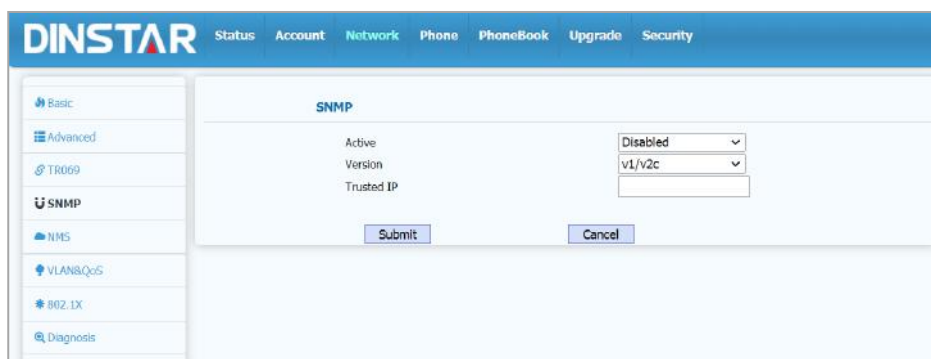

Sections	Description
SNMP	<p>SNMP settings.</p> <ul style="list-style-type: none"> <li>• Active: To enable or disable SNMP feature.</li> <li>• Version: Select the supported SNMP version.</li> <li>• Trusted IP: To configure allowed SNMP server address, it could be an IP address or any valid URL domain name.</li> </ul> <p><b>Note:</b> SNMP (Simple Network Management Protocols) is Internet-standard protocol for managing devices on IP networks.</p>

### 5.4.5 Network ->NMS

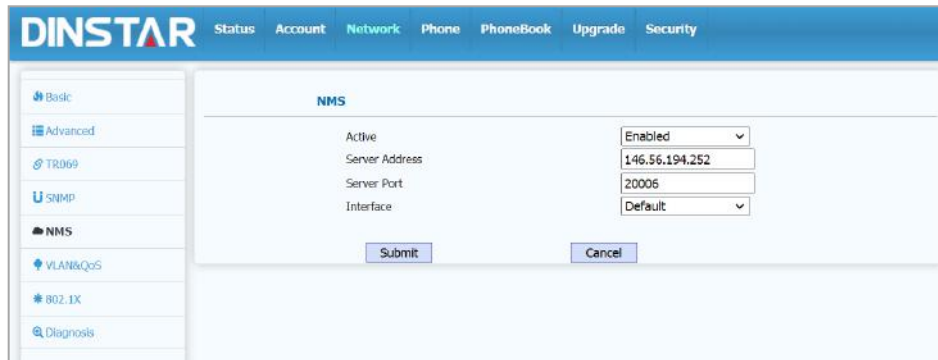

Sections	Description
NMS	<p>It configures NMS feature.</p> <ul style="list-style-type: none"> <li>Active: Enable or disable NMS function.</li> <li>Server Address: The address of the NMS server.</li> <li>Server Port: The port of the NMS server.</li> <li>Interface: Configure the local interface for accessing the NMS server, which is default in DHCP and static IP mode, PPPoE in PPPoE mode, and default, tap0 or tun0 as appropriate after the VPN is turned on.</li> </ul>

### 5.4.6 Network ->VLAN&QoS

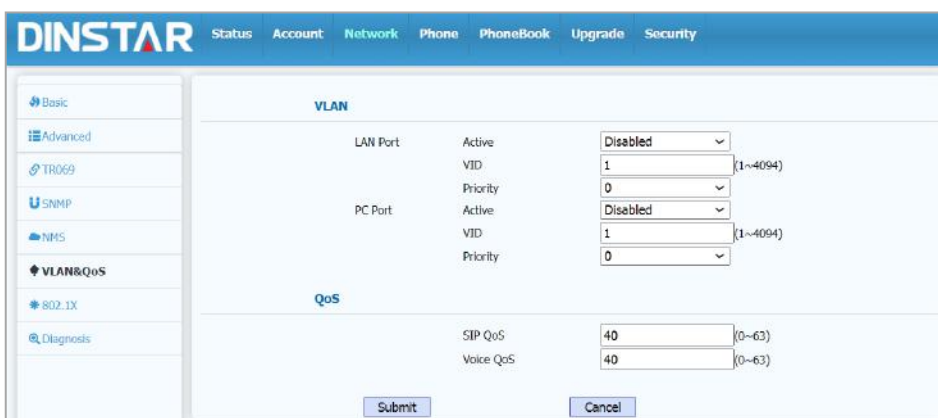

Sections	Description
VLAN	<p>VLAN settings.</p> <ul style="list-style-type: none"> <li>LAN Port/PC Port: You can configure VLAN setting for both</li> </ul>



---

Sections	Description
	<p>ports respectively.</p> <ul style="list-style-type: none"><li>• Active: To enable or disable VLAN feature for designated port.</li><li>• VID: To configure VLAN id for designated port.</li><li>• Priority: To select VLAN priority for designated port.</li></ul> <p>Note: Please consult your administrator for specific VLAN settings in your networking environment.</p>
QoS	<p>QoS settings.</p> <ul style="list-style-type: none"><li>• SIP QoS: To configure QoS value for all SIP message.</li><li>• Voice QoS: To configure QoS value for all audio stream (RTP streams).</li></ul>

## 5.4.7 Network ->802.1X

**DINSTAR** Status Account Network Phone PhoneBook Upgrade Security

Basic  
Advanced  
TR069  
SNMP  
NMS  
VLAN&QoS  
\*802.1X  
Diagnosis

### 802.1X

802.1X Mode: Disabled  
 Provisioning Mode: Unauthenticated Pr  
 Anonymous ID:   
 Identity:   
 Password:

Submit Cancel

### CA Certificate

Index	Issue To	Issuer	Expire Time
1			
2			
3			
4			
5			

Delete Cancel

### CA Certificate index Select

Index: 1

### CA Certificate Upload

Index: Auto  
 Browse not selected Submit Cancel

### Device Certificate

Index	Issue To	Issuer	Expire Time
1			
2			
3			
4			
5			

Delete Cancel

### Device Certificate index Select

Index: 1

### Device Certificate Upload

Index: Auto  
 Browse not selected Submit Cancel

Submit Cancel

Sections	Description
802.1X	<p>It configures 802.1X feature.</p> <ul style="list-style-type: none"> <li>802.1X Mode: To enable or disable 802.1X.</li> <li>Anonymous ID: Configure the anonymous ID used to hide the real 802.1X user.</li> <li>Identity: Configure the username used for 802.1X.</li> </ul>

Sections	Description
	<ul style="list-style-type: none"> <li>Password: Configure the password used for 802.1X.</li> </ul>
CA Certificate	Display or delete the CA certificate, which is used to verify the authenticity of the device certificate.
CA Certificate Upload	Upload the file that will be used as the CA certificate.
Device Certificate	Display or delete the device certificate, which is used to verify the identity of the device with the 802.1X server.
Device Certificate Upload	Upload the file that will be used as the device certificate.

### 5.4.8 Network ->Diagnosis

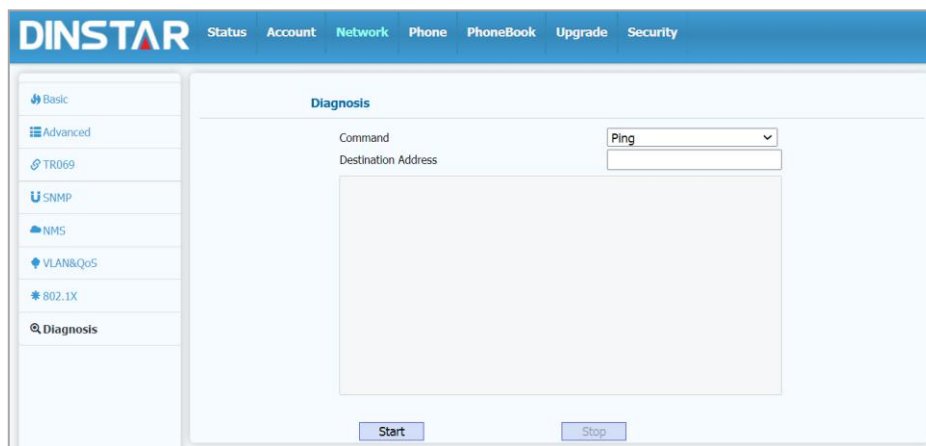

Sections	Description
Diagnosis	Used to detect network connectivity

## 5.5 Phone

### 5.5.1 Phone->Basic

The screenshot shows the DINSTAR web interface for configuring a phone. The 'Basic' section is active, and the following settings are visible:

- LCD Language:** English (dropdown)
- Headset Mode:** Ringing from: Speaker (dropdown)
- Key Tone:** Volume: 5 (input field, range 0~10)
- Ringtone Volume:** Volume: 3 (input field, range 0~10)
- Display:**
  - Backlight Level: 1 (dropdown)
  - Backlight Time: Always On (dropdown)
  - Screensaver Time: 30 (dropdown)

Buttons for 'Submit' and 'Cancel' are located at the bottom of the configuration area.

Sections	Description
<b>LCD Language</b>	choose the phone language.
<b>Headset Mode</b>	<ul style="list-style-type: none"> <li>• Ringing from: When in headset mode, select the ringing from the speaker or headset</li> </ul>
<b>Key Tone</b>	<p>Adjust the sound volume for key press.</p> <ul style="list-style-type: none"> <li>• Volume: The valid volume range is from 0~10, by default it's 5.</li> </ul>
<b>Ringtone Volume</b>	<p>Adjust the sound volume for ringtone.</p> <ul style="list-style-type: none"> <li>• Volume: The valid volume range is from 0~10, by default it's 5</li> </ul>
<b>Display</b>	<ul style="list-style-type: none"> <li>• Backlight Level: Adjust the backlight intensity of the phone interface.</li> <li>• Backlight Time: Adjust the backlight timer, once it expires, the backlight on the phone interface will dim.</li> <li>• Screensaver Time: Adjust the standby time of the screen saver on.</li> </ul> <p><b>Note:</b> The screen saver standby timer starts only when the phone is in the main interface. If the backlight is off, the screen saver will turn off.</p>

## 5.5.2 Phone-Time&Date

**DINSTAR** Status Account Network Phone PhoneBook Upgrade Security

Basic  
Time&Date  
Call Feature  
Voice  
Key  
Ringtones  
Tones  
Dial Plan  
Action URL  
Multicast  
Forward&DND  
Intercom  
ACD

**Format Setting**

Time Format: 12Hour  
Date Format: DD/MM/YYYY  
Display Mode: Date

**Time&Date**

Manual  
Date: Year Mon Day  
Time: Hour Min Sec

NTP  
Time Zone: +8 China(Beijing)  
Primary Server: 0.pool.ntp.org  
Secondary Server: 1.pool.ntp.org  
Update Interval: 3600 (>= 3600s)

**Daylight Saving Time**

Active: Auto  
OffSet: 60 (-300~300Minutes)

By Date  
Start Time: 1 Mon 1 Day 0 Hour  
End Time: 12 Mon 31 Day 23 Hour

By Week  
Start Month: Jan  
Start Week Of Month: First In Month  
Start Day Of Week: Monday  
Start Hour: 0 (0~23)  
End Month: Dec  
End Week Of Month: Fourth In Month  
End Day Of Week: Sunday  
End Hour: 23 (0~23)

**Daily Reboot**

Active: Disabled  
Reboot Time: 0 : 0

Submit Cancel

Sections	Description
Format Setting	<p>Time and date format settings.</p> <ul style="list-style-type: none"> <li>Time Format: Determine what format to display on Phone UI (12 hour/24 hour).</li> <li>Date Format: Determine what format to display on Phone UI for Date.</li> <li>Display Mode: Determine what mode to display Time&amp;Date on Phone UI.</li> </ul>
Time&Date	To select how to configure time, it could be set manually or

Sections	Description
	<p>get from INTERNET automatically via NTP server.</p> <ul style="list-style-type: none"> <li>• Manual: To set Time and Date manually.</li> </ul> <p><b>Note:</b> If you set time to be Manually, it only takes effect till next reboot, after reboot, the phone will switch to Auto mode automatically, because there is no way for IP phone to record time during power off.</p> <ul style="list-style-type: none"> <li>• NTP: To get Time via NTP server.</li> <li>• Time Zone: To select local Time Zone for NTP server.</li> <li>• Primary Server: To configure primary NTP server address.</li> <li>• Secondary Server: To configure secondary NTP server address, it takes effect if primary NTP server is unreachable.</li> <li>• Update Interval: To configure interval between two consecutive NTP requests.</li> </ul> <p><b>Note:</b> NTP, Network Time Protocol is used to automatically synchronized local time with INTERNET time, since NTP server only response GMT time, so that you need to specify the Time Zone for IP phone to decide the local time.</p>
<b>Daylight Saving Time</b>	<p>DST settings.</p> <p><b>Note:</b> Here DST, is short for Daylight saving time, which stands for the time in the summer days when sun rises early will be adjusted forward to save daylight. The DST will take effects during the period that set by user. (all the settings for DST are all self-explanatory, please consult with your administrator for local DST details).</p>
<b>Daily Reboot</b>	Set the phone's daily restart time

## 5.5.3 Phone- Call Feature

The screenshot shows the Dinstar web interface for configuring call features. The navigation menu includes Status, Account, Network, Phone, PhoneBook, Upgrade, and Security. The left sidebar lists various settings categories, with 'Call Feature' selected. The main content area is titled 'Call Feature' and contains the following sections:

- Call Waiting:**
  - Active: Enabled (dropdown)
  - CallWaiting Tone: Enabled (dropdown)
  - On Code: (input field)
  - Off Code: (input field)
- Auto Redial:**
  - Auto Redial: Disabled (dropdown)
  - Auto Redial Interval: 10 (input field, range 1~300s)
  - Auto Redial Times: 3 (input field, range 1~100)
- BLF Pickup Alert:**
  - BLF Pickup Alert: Disabled (dropdown)
- Remote Control:**
  - Allowed Access IP List: any (input field)
- Others:**
  - Reject Response Code: 486 (Busy Here) (dropdown)
  - Auto Answer Delay: 0 (input field, range 0~5s)
  - Auto Hangup Time: 2 (input field, range 1~30s)
  - Early DTMF: Disabled (dropdown)
  - Multicast Codec: PCMU (dropdown)

At the bottom of the configuration area are 'Submit' and 'Cancel' buttons.

Sections	Description
<b>Call Waiting</b>	<p>It enables or disables Call Waiting.</p> <ul style="list-style-type: none"> <li>Active: If enabled, it allows IP phones to receive a new incoming call when there is already an active call.</li> <li>Call Waiting Tone: If enabled, it allows IP phones to play the call waiting tone to the waiting callee.</li> </ul>
<b>Auto Redial</b>	<p>Auto redial allows IP phones to redial an unsuccessful call for designated times within designated interval.</p> <ul style="list-style-type: none"> <li>Auto Redial: To enable or disable auto redial feature.</li> <li>Auto Redial Interval: Determine the interval between two consecutive attempts.</li> <li>Auto Redial Times: Determine how many times to redial.</li> </ul>
<b>Call Pick Up Alert</b>	<p>Visual BLF Pick Up Alert: To enable the BLF pick up function.</p>
<b>Remote Control</b>	<p>Remote Control allows specific host to interact with IP phone by sending HTTP or HTTPS requests. The specific</p>

Sections	Description
	<p>action could be answering an incoming call, hangup an ongoing call and so on.</p> <ul style="list-style-type: none"> <li>Allowed Access IP List: To configure the allowed host address.</li> </ul> <p><b>Note:</b> For now, IP phone can only support IP address, IP address list and IP address pattern as allowed hosts.</p>
Others	<ul style="list-style-type: none"> <li>Reject Response Code: Allows user to assign specific code as return code to SIP server when an incoming call is rejected.</li> <li>Auto Answer Delay: To configure delay time before an incoming call is automatically answered.</li> <li>Auto Hangup Time: To configure the time from the busy tone to the standby state after the other party hangs up.</li> <li>Early DTMF: To enable or disable early DTMF.</li> <li>Multicast codec: To choose different multicast codec.</li> </ul>

### 5.5.4 Phone-Voice

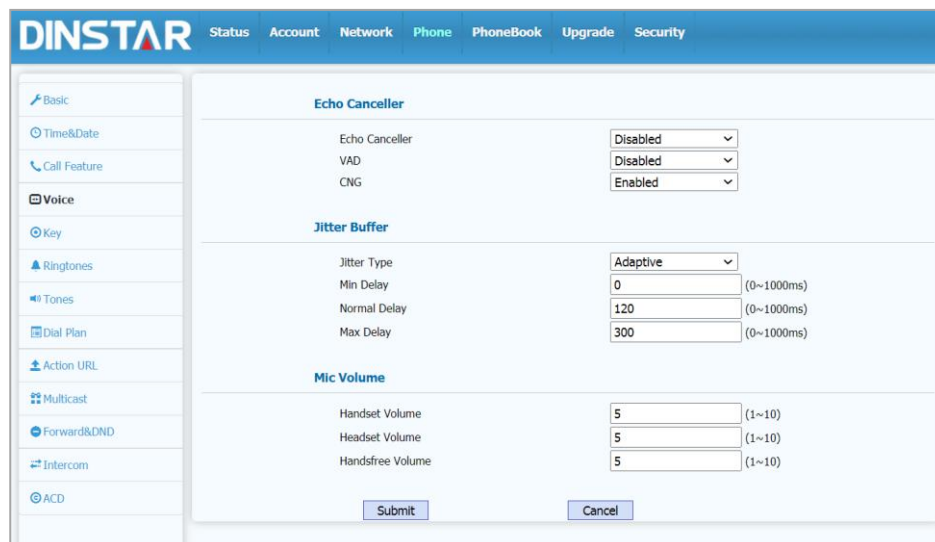

Sections	Description
Echo Cancellor	<ul style="list-style-type: none"> <li>Echo Cancellor: To remove acoustic echo from a voice communication in order to improve the voice quality.</li> <li>VAD (Voice Activity Detection): Allow IP phone to detect</li> </ul>



Sections	Description
	<p>the presence or absence of human speech during a call. When detecting period of “silence”, VAD replaces that silence efficiently with special packets that indicate silence is occurring. It can facilitate speech processing, and deactivate some processes during non-speech section of an audio session. It can avoid unnecessary coding or transmission of silence packets in VoIP applications, saving on computation and network bandwidth.</p> <ul style="list-style-type: none"> <li>• CNG (Comfort Noise Generation): Allow IP phone to generate comfortable background noise for voice communications during periods of silence in a conversation. It is a part of the silence suppression or VAD handling for VoIP technology. CNG, in conjunction with VAD algorithms, quickly responds when periods of silence occur and inserts artificial noise until voice activity resumes. The insertion of artificial noise gives the illusion of a constant transmission stream, so that background sound is consistent throughout the call and the listener does not think the line has released.</li> </ul>
<b>Jitter Buffer</b>	<p>Jitter buffer is a shared data area where voice packets can be collected, stored, and sent to the voice processor in even intervals. Jitter is a term indicating variations in packet arrival time, which can occur because of network congestion, timing drift or route changes. The jitter buffer, located at the receiving end of the voice connection, intentionally delays the arriving packets so that the end user experiences a clear connection with very little sound distortion. IP phones support two types of jitter buffers: fixed and adaptive.</p> <ul style="list-style-type: none"> <li>• Fixed: Add the fixed delay to voice packets. You can configure the delay time for the static jitter buffer on IP phones.</li> <li>• Adaptive: Capable of adapting the changes in the network's delay. The range of the delay time for the dynamic jitter buffer added to packets can be also configured on IP phones.</li> <li>• Min Delay: Set the minimum delay time</li> </ul>

Sections	Description
	<ul style="list-style-type: none"> <li>Normal Delay: Set normal delay time</li> <li>Max Delay: Set the maximum delay time</li> </ul>
<b>Mic Volume</b>	Adjust microphone volume for headset, handset and speaker mode.

### 5.5.5 Phone->Key

The screenshot shows the 'Phone->Key' configuration page in the DINSTAR web interface. The page is divided into several sections:

- Line Key:** A table with columns: Key, Type, Label, Value, Account, Extension. It shows two entries: Line Key 1 (Account) and Line Key 2 (Account).
- Soft Key:** A table with columns: Key, Type, Label, Value, Account. It shows four entries: Soft Key 1 (History), Soft Key 2 (Book), Soft Key 3 (DND), and Soft Key 4 (Menu).
- Function Key:** A table with columns: Key, Type, Value, Account. It shows three entries: OK (Status), Cancel (N/A), and Mute (N/A).
- Keypad Lock:** Fields for Keypad Lock Type (Disabled), Keypad Unlock PIN (\*\*\*\*\*), and Keypad Lock Timeout (0).
- Key As Send:** A field for Key As Send ( # ).

Buttons for 'Submit' and 'Cancel' are located at the bottom of the configuration area.

Sections	Description
<b>Line Key</b>	<p>Allows user to assign specific feature to the designated line key. For line key, the available feature list:</p> <p>DND, Menu, MSG, Status, Book, Fwd, PickUp, Group PickUp, Intercom, Speed Dial, History, Favorites, Redial, Account, ACD, BLF, BLFList, Call Return, Hot Desking, Record, XML Browser, DTMF, Multicast Paging, Voice Message, Transfer, Call Park, XML History, XML PhoneBook.</p>
<b>Soft Key</b>	<p>Allows user to assign specific feature to the designated soft keys. For soft key, the following is the available features:</p> <p>DND, Menu, MSG, Status, Book, Fwd, PickUp, Group PickUp, Intercom, Speed Dial, History, Favorites, Redial, Call Return, Hot Desking, XML Browser, simple Menu, Voice Message, XML History, XML PhoneBook, ACD.</p>

Sections	Description
<b>Function Key</b>	<p>Allows user to assign specific feature to the designated function keys. For function keys, the available features are as follows:</p> <p>DND, Menu, MSG, Status, Book, Fwd, PickUp, Group PickUp, Intercom, Speed Dial, History, Favorites, Redial, Call Return, Hot Desking, XML Browser, Voice Message, Transfer, XML History, XML PhoneBook.</p>
<b>Keypad Lock</b>	<p>Keypad lock can temporarily lock the phone keypad when not in use. This feature helps prevent unauthorized use of the phone.</p> <ul style="list-style-type: none"> <li>Keypad Lock Type: Choose to lock function keys or all keys.</li> <li>Keypad Unlock PIN: The password for lock.</li> <li>Keypad Lock Timeout: The idle interval for locking the phone.</li> </ul>
<b>Key As Send</b>	<p>" Key As Send " allow you to disable the send key or assign the # key and * key as the send key.</p>

### 5.5.6 Phone-Ringtones

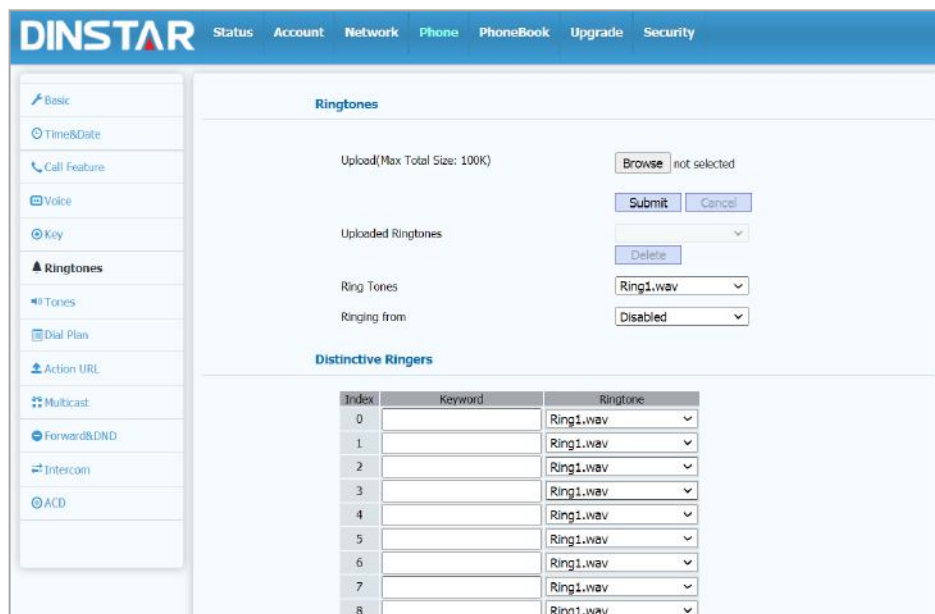

Sections	Description
<b>Ringtones</b>	<p>Allows user to upload and view ringtone files or delete uploaded ringtone files.</p> <p><b>Note:</b> Ringtone files must be in.wav format and have some</p>

Sections	Description
	specific requirements, please contact technical support team for instructions how to make ringtone files. system ringtone files cannot be deleted thus user can only delete uploaded ringtone.
<b>Distinctive Ringers</b>	Distinctive ringers allow different incoming calls to trigger distinctive ringtone. The IP phone will check "Alert-Info" header inside the incoming "invite" SIP message. And strip out the URL or keyword inside the "Alert-Info" header, from the specific URL or keyword to match or download designated ringtone to play.

### 5.5.7 Phone-Tones

**Tones**

Select Country or Region Default

Busy Tone 480+620/500,0/500

RingBack Tone 440+480/2000,0/4000

Dial Tone 350+440

Sections	Description
<b>Tones</b>	Allows users to select tones (classified by country or region) or customize tones.

### 5.5.8 Phone ->Dial Plan Rule

a) **Phone-Dial Plan-Replace Rule**

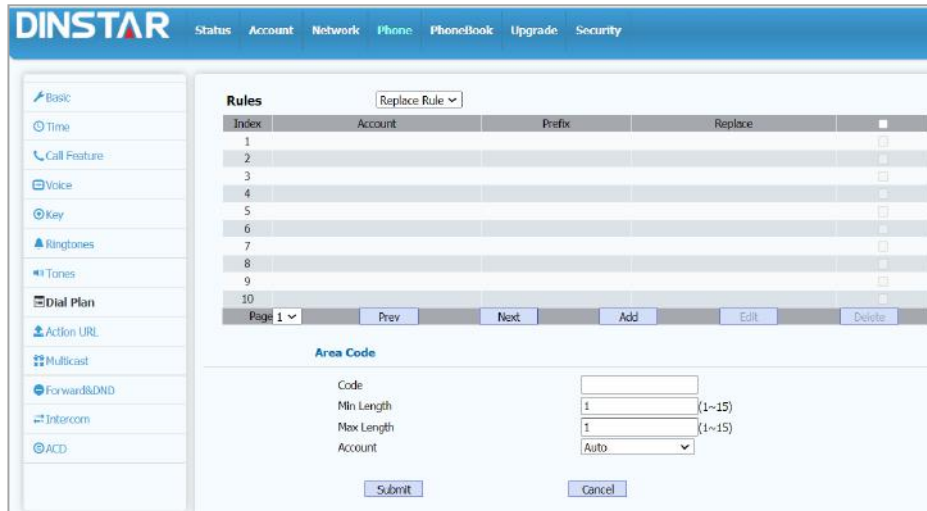

Sections	Description
Rules	Allows user to select Replace rule or Dial-now to display or edit. For replace rules, you can add, modify, or delete prefix for accounts.
Area Code	Area codes are also known as NPAs (Numbering Plan Areas). They usually indicate different geographical areas within one country. If entered numbers match the predefined area code rule, the IP phone will automatically prefix outgoing number with area code.  <b>Note:</b> There is only one area code rule supported.

b) Phone-Dial Plan-Dial Now

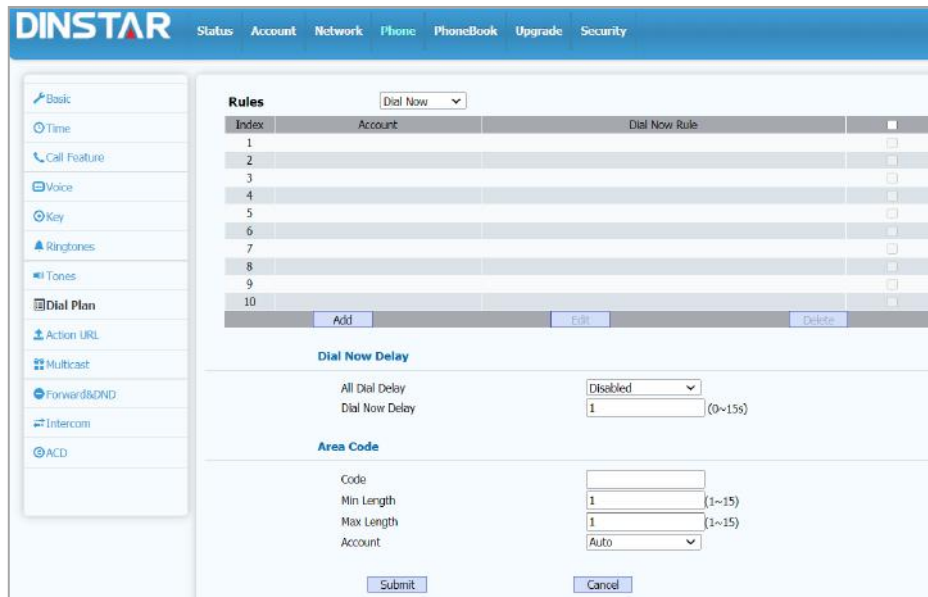

Sections	Description
<b>Rules</b>	Allows user to select Replace rule or Dial-now to display or edit. For Dial Now, you can add, modify, or delete prefix for accounts.
<b>Dial Now Delay</b>	Allows user configure dial now delay time for dial now. It means user can configure the IP phone to dial out the phone number automatically after the designated delay time if it matches any dial now rule.
<b>Area Code</b>	Area codes are also known as NPAs (Numbering Plan Areas). They usually indicate different geographical areas within one country. If entered numbers match the predefined area code rule, the IP phone will automatically prefix outgoing number with area code.  <b>Note:</b> There is only one area code rule supported.

## 5.5.9 Phone-Action URL

Event	Value
Active	Enabled
Setup Completed	
Registered	
Unregistered	
Registered Failed	
Off Hook	http://172.19.151.161:8080/?action=offhook&ip=\$
On Hook	
Incoming Call	
Outgoing Call	
Established	
Terminated	
Open DND	
Close DND	
Open Always FWD	
Close Always FWD	
Open Busy FWD	
Close Busy FWD	
Open No Answered FWD	
Close No Answered FWD	
Transfer Call	
Blind Transfer	
Attended Transfer	
Hold	
UnHold	
Mute	
UnMute	
Missed Call	
IP Changed	
FWD Incoming Call	
Reject Incoming Call	
Answer New Call	
Transfer Finished	
Transfer Failed	
Idle To Busy	
Busy To Idle	

Sections	Description
Action URL	<p>Action URL settings.</p> <ul style="list-style-type: none"> <li>• Active: Enable or disable ActionURL</li> <li>• Setup Completed: When the IP phone completes startup.</li> <li>• Registered: When the IP phone successfully registers an account.</li> <li>• Unregistered: When the IP phone logs off the registered account.</li> <li>• Register Failed: When the IP phone fails to register an account.</li> </ul>

Sections	Description
	<ul style="list-style-type: none"><li>• Off Hook: When the IP phone is off hook.</li><li>• On Hook: When the IP phone is on hook.</li><li>• Incoming Call: When the IP phone receives an incoming call.</li><li>• Outgoing Call: When the IP phone places a call.</li><li>• Established: When the IP phone establishes a call.</li><li>• Terminated: When the IP phone terminates a call.</li><li>• Open DND: When the IP phone enables the DND mode.</li><li>• Close DND: When the IP phone disables the DND mode.</li><li>• Open Always FWD: When the IP phone enables the always forward.</li><li>• Close Always FWD: When the IP phone disables the always forward.</li><li>• Open Busy FWD: When the IP phone enables the busy forward.</li><li>• Close Busy FWD: When the IP phone disables the busy forward.</li><li>• Open No Answer FWD: When the IP phone enables the no answer forward.</li><li>• Close No Answer FWD: When the IP phone disables the no answer forward</li><li>• Transfer Call: When the IP phone transfers a call.</li><li>• Blind Transfer: When the IP phone blind transfers a call.</li><li>• Attended Transfer: When the IP phone performs the semi-attended/attended transfer.</li><li>• Hold: When the IP phone places a call on hold.</li><li>• UnHold: When the IP phone retrieves a hold call.</li><li>• Mute: When the IP phone mutes a call.</li><li>• UnMute: When the IP phone un-mutes a call.</li><li>• Missed Call: When the IP phone misses a call.</li><li>• IP Changed: When the IP address of the IP phone changes.</li><li>• FWD Incoming Call: When the IP phone forwards an</li></ul>



Sections	Description
	<p>incoming call.</p> <ul style="list-style-type: none"> <li>Reject Incoming Call: When the IP phone rejects an incoming call.</li> <li>Answer New Call: When the IP phone answers a new call.</li> <li>Transfer Finished: When the IP phone completes to transfer a call.</li> <li>Transfer Failed: When the IP phone fails to transfer a call.</li> <li>Idle To Busy: When the state of the IP phone changes from idle to busy.</li> <li>Busy To Idle: When the state of phone changes from busy to idle.</li> </ul>

### 5.5.10 Phone ->Multicast

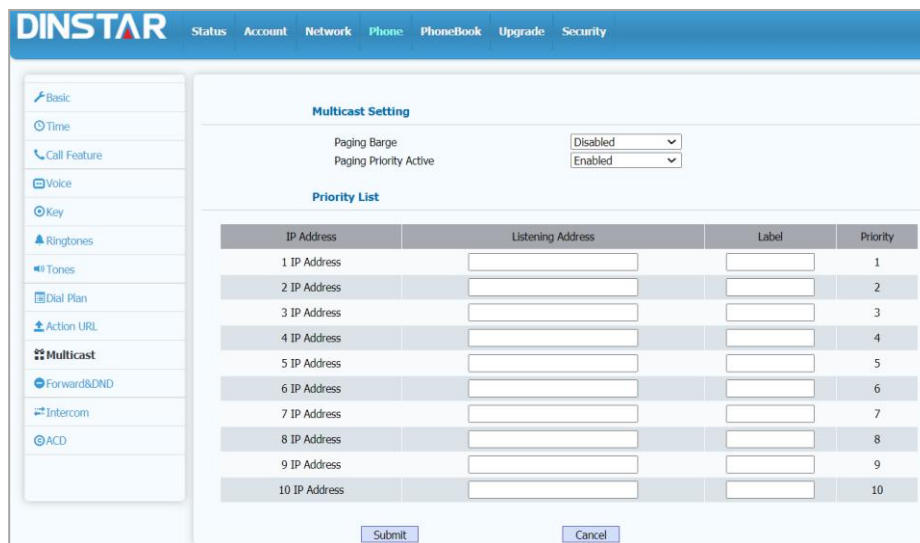

Sections	Description
<b>Multicast Setting</b>	<p>Multicast setting.</p> <ul style="list-style-type: none"> <li>Paging Barge: Choose the multicast number, the range is 1-10.</li> <li>Paging priority Active: Enable o disable the multicast.</li> </ul>
<b>Priority List</b>	It configures the multicast parameters.

- Listening Address: Enter the IP address you need to listen.
- Label: Input the label for each listening address

### 5.5.11 Phone->Forward & DND

The screenshot shows the DINSTAR web interface for configuring Forward & DND settings. The interface includes a navigation menu on the left and a main configuration area with sections for Sync Feature Code, Forward Transfer, and DND. Each section contains various settings like Account, Mode, Always Forward, Target Number, On Code, Off Code, and timers.

Sections	Description
Sync Feature Code	<ul style="list-style-type: none"> <li>• Active: enable or disable function synchronization.</li> <li>• Mode: select the desired mode.</li> </ul>
Forward Transfer	<p>Forward settings:</p> <p><b>Note:</b> There are three types of forwarding: Always Forward, Busy Forward, and No Answer Forward.</p> <ul style="list-style-type: none"> <li>• Account: Select the account that needs to enable forwarding</li> <li>• Always Forward: calls will be forwarded under any circumstances.</li> <li>• Target Number: Set the always forward target number;</li> <li>• On Code: After setting the On Code, the user can dial</li> </ul>

Sections	Description
	<p>the On Code + target number to enable always forward;</p> <ul style="list-style-type: none"> <li>• Off Code: After setting the Off Code, the user can dial the Off Code + target number to disable the always forward;</li> <li>• Busy Forward: if the IP phone is busy, the call will be forwarded.</li> <li>• Target Number: Set the busy forward target number;</li> <li>• On Code: After setting the On Code, the user can dial the On Code + target number to enable busy forward;</li> <li>• Off Code: After setting the Off Code, the user can dial the Off Code + target number to disable the busy forward;</li> <li>• No Answer Forward: If no one answers after a certain time, the call will be forwarded.</li> <li>• No Answer Ring Time: Set the no answer ring time, if no one answers within the set time, the call will be forwarded;</li> <li>• Target Number: Set the no answer forward target number;</li> <li>• On Code: After setting the On Code, the user can dial the On Code + target number to enable no answer forward;</li> <li>• Off Code: After setting the Off Code, the user can dial the Off Code + target number to disable the no answer forward;</li> </ul>
DND	<p>Do not disturb allows the IP phone to ignore any incoming call:</p> <ul style="list-style-type: none"> <li>• Account: Select the account that needs to enable the DND function</li> <li>• DND: Enable or disable DND</li> <li>• Return Code When DND: Determine what response code should be sent back to the server when do not disturb is turned on and there is an incoming call.</li> </ul>

Sections	Description
	<ul style="list-style-type: none"> <li>• DND On Code: The code used to turn on DND on the server (if configured), if you press DND when the DND is off, the IP phone will send a SIP message to the server to turn on DND on the server .</li> <li>• DND Off Code: The code used to turn off DND on the server (if configured), if you press DND when it is turned on, the IP phone will send a SIP message to the server to turn off DND on the server.</li> <li>• DND Timer Enable: Enable or disable DND timer. The DND timer can make DND take effect in a specified time period.</li> </ul> <p><b>Note:</b> The DND timer can only be enabled when DND is turned on.</p>

### 5.5.12 Phone->Intercom

**Intercom**

Active Enabled

Intercom Mute Disabled

Sections	Description
Intercom	<p>Intercom allows users to directly calls with the other party:</p> <ul style="list-style-type: none"> <li>• Active: Enable or disable the intercom function.</li> <li>• Intercom Mute: After enabling, once a call is established, the phone will be muted by default.</li> </ul>

### 5.5.13 Phone->ACD

ACD	
ACD Activated Auto	<input type="text" value="Disabled"/>
ACD Activated Auto Timer	<input type="text" value="90"/> (0~180s)
<input type="button" value="Submit"/>	<input type="button" value="Cancel"/>

Sections	Description
ACD	<p>ACD (Automatic Call Distribution) is the most commonly used in the call center. It allows IP phones to log in to the system in multiple states so that the system can distribute incoming calls to available users or agents.</p> <ul style="list-style-type: none"><li>• ACD Activated Auto: If activated, the phone will automatically become available within a specified time (determined by the ACD automatic activation time).</li><li>• ACD Activated Auto Timer: Configure the time interval for the phone to automatically become available.</li></ul>

## 5.6 PhoneBook

### 5.6.1 PhoneBook -> Local Book

**DINSTAR** Status Account Network Phone PhoneBook Upgrade Security

Local Book  
Remote Book  
Call History  
LDAP  
Broadsoft

Contact: All Contacts

Search: [ ] Search Reset

Dial: [ ] Auto Dial Hand Up

Index	Name	Office Number	Mobile Number	Other Number	Group	Ring	Account	
1	ada	818			Default	Auto	Auto	<input type="checkbox"/>
2	kit	669			Default	Auto	Auto	<input type="checkbox"/>
3	test1	8888			Default	Auto	Auto	<input type="checkbox"/>
4								<input type="checkbox"/>
5								<input type="checkbox"/>
6								<input type="checkbox"/>
7								<input type="checkbox"/>
8								<input type="checkbox"/>
9								<input type="checkbox"/>
10								<input type="checkbox"/>

Page 1 Prev Next Move To All Contacts Delete Delete All

**Contact Setting**

Name: [ ] Office Number: [ ]  
 Mobile Number: [ ] Other Number: [ ]  
 Group: Default Ring: Auto  
 Account: Auto

Add Edit Cancel

**Group**

Index	Name	Ring	Description	
1				<input type="checkbox"/>
2				<input type="checkbox"/>
3				<input type="checkbox"/>
4				<input type="checkbox"/>
5				<input type="checkbox"/>
6				<input type="checkbox"/>
7				<input type="checkbox"/>
8				<input type="checkbox"/>
9				<input type="checkbox"/>
10				<input type="checkbox"/>

Delete Delete All

**Group Setting**

Name: [ ] Ring: Auto  
 Description: [ ]

Add Edit Cancel

**Import/Export**

Export Format: .XML

Contact: Browse not selected (XML/CSV/VCF)  
 Import Export Cancel

Black List: Browse not selected (XML/CSV/VCF)  
 Import Export Cancel

White List: Browse not selected (XML/CSV/VCF)  
 Import Export Cancel

Sections	Description
<b>Contact</b>	To select the type for local book. <ul style="list-style-type: none"> <li>All Contacts: To display or edit all local contacts.</li> <li>Favorites: To display or edit favorites contacts.</li> <li>Black List: To display black list contacts.</li> <li>White List: To display white list contacts.</li> </ul>
<b>Search</b>	To search designated contacts from local phonebook.
<b>Dial</b>	Dial out a call or hangup an ongoing call from Web UI.  Note: For this feature, you need to have the remote control privilege to control IP phone via Web UI. Please refer to section “Remote Control” in the Web UI-> Phone -> Call Feature page.
<b>Group Setting</b>	Management group contacts.
<b>Import/Export</b>	Import or export the contact or blacklist file.

## 5.6.2 PhoneBook -> Remote Book

The screenshot displays the 'Remote Book' configuration interface. It features a table with the following structure:

Index	Remote URL	Display Name
1		
2		
3		
4		
5		

Below the table, there are configuration options:

- Search Remote Phonebook Name:
- Refresh Interval:  (120~2592000s)

Buttons for 'Submit' and 'Cancel' are located at the bottom of the configuration area.

Sections	Description
<b>Remote Book</b>	Remote Book settings. <ul style="list-style-type: none"> <li>Index: To select desired Remote Book item to display and configure.</li> <li>Remote URL: To configure remote book server address.</li> <li>Display Name: To configure display remote book name on Phone UI.</li> </ul>

- Search Remote Phonebook Name: To enable or disable search remote phonebook name.
  - Reflash Interval: To set interval (Range from 120s to 2592000s).
- Note:** IP phone supports at most 5 remote books. Please refer to your administrator for how to establish a remote book server and how to create remote book xml file.

### 5.6.3 PhoneBook -> Call History

Index	Type	Time	Local Identity	Name	Number	Call Duration	Account	RTP Send	RTP Recv	Lost (%)	Jitter (ms)	Delay (ms)
1	Missed	2021-03-02 17:49:02	606	10000	25884995@172.16.0.8	00:00:00	2	0	0	0	0	0
2	Missed	2021-03-02 13:54:46	606	10000	130292008510@172.16.0.8	00:00:00	2	0	0	0	0	0
3	Missed	2021-03-02 09:53:55	606	037189910044	037189910044@172.16.0.8	00:00:00	2	0	0	0	0	0
4	Missed	2021-03-02 09:53:21	606	037189910044	037189910044@172.16.0.8	00:00:00	2	0	0	0	0	0
5	Missed	2021-03-02 09:43:31	606	02136509998	02136509998@172.16.0.8	00:00:00	2	0	0	0	0	0
6	Missed	2021-03-02 09:40:01	606	02136509998	02136509998@172.16.0.8	00:00:00	2	0	0	0	0	0
7	Missed	2021-03-02 09:38:04	606	02136509998	02136509998@172.16.0.8	00:00:00	2	0	0	0	0	0
8	Missed	2021-03-02 09:37:22	606	02136509998	02136509998@172.16.0.8	00:00:00	2	0	0	0	0	0
9	Missed	2021-03-02 09:04:58	606	10000	18642252666@172.16.0.8	00:00:00	2	0	0	0	0	0
10	Dialed	2020-12-31 15:22:50	6002	123456	123456@172.28.20.120	00:00:00	0	0	0	0	0	0
11	Missed	2020-12-31 14:25:40	606	15641953334	15641953334@172.16.0.8	00:00:00	0	0	0	0	0	0
12	Missed	2020-12-31 14:25:10	606	15641953334	15641953334@172.16.0.8	00:00:00	0	0	0	0	0	0
13	Missed	2020-12-31 13:41:06	606	17604887197	17604887197@172.16.0.8	00:00:00	0	0	0	0	0	0
14	Missed	2020-12-31 13:40:46	606	17604887197	17604887197@172.16.0.8	00:00:00	0	0	0	0	0	0
15	Missed	2020-12-31 13:40:16	606	17604887197	17604887197@172.16.0.8	00:00:00	0	0	0	0	0	0

Sections	Description
Call History	<p>Available call history types are All calls, Dialed calls, Received calls, Missed calls, Forwarded calls.</p> <ul style="list-style-type: none"> <li>• Hang Up: To click to hangup ongoing call on the IP phone.</li> </ul> <p><b>Note:</b> For “HangUp” feature, you need to have the remote control privilege to control IP phone via Web UI. Please refer to section “Remote Control” in the Web UI -&gt; Phone -&gt; Call Feature page.</p>



## 5.6.4 PhoneBook -> LDAP

The screenshot shows the Dinstar web interface for configuring LDAP settings. The navigation menu on the left includes: Local Book, Remote Book, Call History, LDAP (selected), and Broadsoft. The main configuration area is titled 'LDAP' and contains the following fields:

- Name Filter:
- Number Filter:
- Server:
- Port:  (1~65535)
- Base:
- Username:
- Password:
- Name Attribute:
- Number Attribute:
- Display Name:
- Max Hits:  (1~500)
- Search Delay Time:  (200~3000)ms
- Lookup for Incoming Call:
- Lookup for Dial:
- Hierarchy View:

Buttons for 'Submit' and 'Cancel' are located at the bottom of the configuration area.

Sections	Description
LDAP	<p>LDAP phonebook settings.</p> <ul style="list-style-type: none"> <li>• Name Filter: The settings used to tell LDAP server what name attributes to search.</li> <li>• Number Filter: The settings used to tell LDAP server what number attributes to search.</li> <li>• Server: To configure LDAP server's address.</li> <li>• Port: To configure LDAP server's port.</li> <li>• Base DN: To configure searching base DN on LDAP server.</li> <li>• User Name: To configure user name for accessing LDAP server.</li> <li>• Password: To configure password for accessing LDAP server.</li> <li>• Name Attribute: To configure which name attributes should be feedback from LDAP server.</li> <li>• Number Attribute: To configure which number attributes should be feedback from LDAP server.</li> <li>• Display Name: To configure display name on Phone UI when there is any searching result from LDAP server.</li> <li>• Max Hits: To configure the maximum size of result response from LDAP server.</li> <li>• Search Delay Time: To configure delay time before initiate</li> </ul>

Sections	Description
	<p data-bbox="596 309 1246 383">LDAP searching request after you input a value from Phone UI.</p> <ul data-bbox="544 416 1246 703" style="list-style-type: none"><li data-bbox="544 416 1246 490">• When this function is enabled, the system will automatically match and display the incoming call information</li><li data-bbox="544 524 1246 645">• When this function is enabled, the system will automatically match the outgoing number with the LDAP phonebook and display the contact information of the number</li><li data-bbox="544 678 983 703">• Set LDAP phone book level display</li></ul> <p data-bbox="544 734 1190 808">When this function is enabled, the system will automatically match and display the incoming call information</p> <p data-bbox="544 842 1190 963">When this function is enabled, the system will automatically match the outgoing number with the LDAP phonebook and display the contact information of the number</p> <p data-bbox="544 996 927 1021">Set LDAP phone book level display</p> <ul data-bbox="544 1055 1246 1435" style="list-style-type: none"><li data-bbox="544 1055 1246 1128">• Lookup for Incoming Call: If enabled, the incoming call will be matched with the LDAP phone book and displayed.</li><li data-bbox="544 1162 1246 1283">• Lookup for Dial: If enabled, it will be matched with the LDAP phonebook and displayed when calling out or replaying.</li><li data-bbox="544 1317 1246 1435">• Hierarchy View: If enabled, the LDAP phone book will display hierarchical directories, such as multiple departments of a company.</li></ul> <p data-bbox="544 1469 1158 1543"><b>Note:</b> For setting details, please consult with your system administrator for further information.</p>

## 5.6.5 PhoneBook -> Broadsoft

Sections	Description
<b>Broadsoft PhoneBook</b>	<p>Broadsoft PhoneBook settings.</p> <ul style="list-style-type: none"> <li>• PhoneBook Item: To select specific item to configure.</li> <li>• Display Name: The name displayed at IP phone's LCD screen when accessed via Phone UI.</li> <li>• Server Address: Broadsoft PhoneBook server's address.</li> <li>• Server Port: Broadsoft PhoneBook server's port.</li> <li>• User Name: Username used to access Broadsoft PhoneBook server.</li> <li>• Password: Password used to access Broadsoft PhoneBook server.</li> </ul> <p><b>Note:</b> IP phone supports at most 5 Broadsoft PhoneBook items. For Broadsoft PhoneBook's server address, port, username and password, you need to consult your Broadsoft service provider for further information.</p>

## 5.7 Upgrade

### 5.7.1 Upgrade->Upgrade

The screenshot shows the 'Upgrade' section of the DINSTAR web interface. The navigation menu on the left includes: Upgrade, Auto Provision, System log, Network Capture, Configuration, PnP, and Custom language. The main content area displays the following information and controls:

- Firmware Version:** 2.62.6.2.1
- Hardware Version:** 62.2.0.0.0.1.6.1
- Upgrade:** A 'Browse' button (not selected), a 'Submit' button, and a 'Cancel' button.
- Reset To Factory Setting:** A 'Submit' button.
- Reboot:** A 'Submit' button.

Sections	Description
<b>Firmware Version</b>	Show you the firmware version
<b>Hardware Version</b>	Show you the hardware version.
<b>Upgrade</b>	To select upgrading rom file from local or a remote server automatically.  <b>Note:</b> Please make sure it's right file format for right model.
<b>Reset to Factory Setting</b>	Allow you to reset IP phone's setting to factory settings.
<b>Reboot</b>	To reboot IP phone remotely from Web UI.

### 5.7.2 Upgrade-Auto Provision

The screenshot shows the 'Auto Provision' section of the DINSTAR web interface. The navigation menu on the left includes: Upgrade, Auto Provision, System log, Network Capture, Configuration, PnP, and Custom language. The main content area displays the following information and controls:

- DHCP Option:** Custom Option (DHCP Option 66/43 is Enabled by Default) with a text input field and '(128~254)'.
- Provisioning Server:**
  - URL:
  - Username:
  - Password:
  - Common AES Key:
  - AES Key(MAC):
- Auto Provision:**
  - Mode:
  - Schedule:
  - (0~23)
  - Min(0~59)
  - Clear MD5:
  - Export Configuration Template:
- Auto Provision Now:**
- Bottom controls:  and

Sections	Description
<b>DHCP Option</b>	<p>It configures custom DHCP option.</p> <ul style="list-style-type: none"> <li>• DHCP Option: If configured, IP Phone will use designated DHCP option to get Auto Provisioning server's address via DHCP.</li> </ul> <p>This setting requires DHCP server to support corresponding option.</p>
Provisioning Server	<p>Update server settings.</p> <ul style="list-style-type: none"> <li>• URL: Auto provisioning server address.</li> <li>• User name: Configure if server needs a username to access, otherwise left blank.</li> <li>• Password: Configure if server needs a password to access, otherwise left blank.</li> <li>• Common AES Key: Used for IP phone to decipher common Auto Provisioning configuration file.</li> <li>• AES Key (MAC): Used for IP phone to decipher MAC-oriented auto provisioning configuration file (for example, file name could be 0c1105888888.conf if IP phone's MAC address is 0c1105888888).</li> </ul> <p><b>Note:</b> AES is one of methods for encryption, it should be configured only configure filed is ciphered with AES, otherwise left blank.</p>
<b>Auto Provision</b>	<p>Auto Provisioning mode settings.</p> <p>This Auto Provisioning mode is actually self-explanatory. For example, mode “Power on” means IP phone will go to do Provisioning every time it powers on.</p> <ul style="list-style-type: none"> <li>• Schedule: Set automatic update time.</li> <li>• Clear MD5: Used to clear MD5 of configuration fil</li> <li>• Export Configuration Template: Export Auto Provisioning configuration template file.</li> </ul>
<b>Auto Provision Now</b>	Auto upgrade now

### 5.7.3 Upgrade->System Log

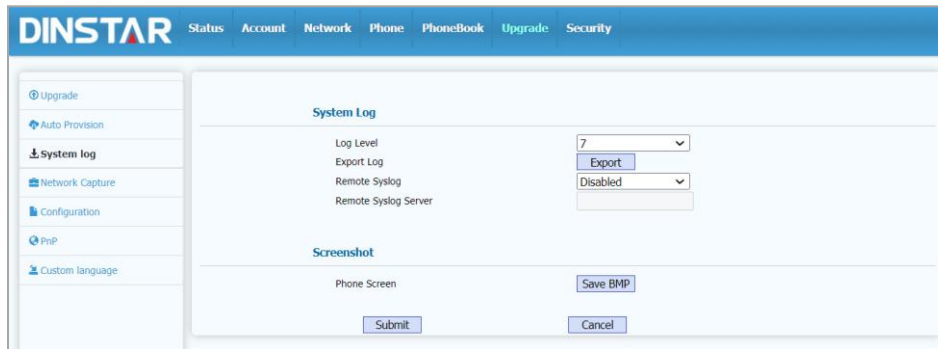

Sections	Description
System Log	<p>To display system log level and export log.</p> <ul style="list-style-type: none"> <li>Log Level: From level 0~7. The higher level means the more specific syslog is saved to a temporary file. By default, it's level 3.</li> <li>Export Log: Click to export temporary syslog file to local PC.</li> <li>Remote System Log: To enable or disable Remote System Log.</li> <li>Remote System Log Server: To input the syslog server address.</li> </ul>
Screenshot	Phone Screen: To capture and save the phone screen

### 5.7.4 Upgrade->Network Capture

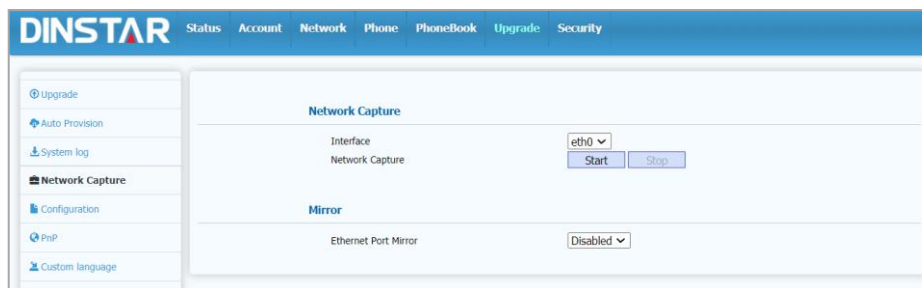

Sections	Description
Network Capture	<p>Network packet capture settings and export data packet:</p> <ul style="list-style-type: none"> <li>Interface: select the interface for network packet capture</li> </ul>

Sections	Description
	<p>(eth0/vpn).</p> <ul style="list-style-type: none"> <li>Start: To start capturing all the packets file sent or received from IP phone.</li> <li>Stop: To stop capturing packets.</li> </ul> <p><b>Note:</b> IP phone will save captured packets file to a temporary file, this file maximum size is 1M (mega bytes), and will top capturing once reaching this maximum size.</p>
<b>Mirror</b>	<p>Network port mirror settings:</p> <ul style="list-style-type: none"> <li>Ethernet Port Mirror: If enabled, the PC port can mirror the packets of the Ethernet port.</li> </ul>

### 5.7.5 Upgrade->Configuration

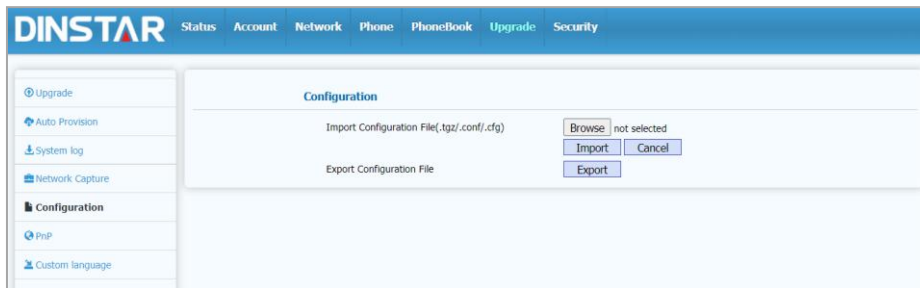

Sections	Description
Configuration	Export or import the configuration file of the IP phone

### 5.7.6 Upgrade->PnP

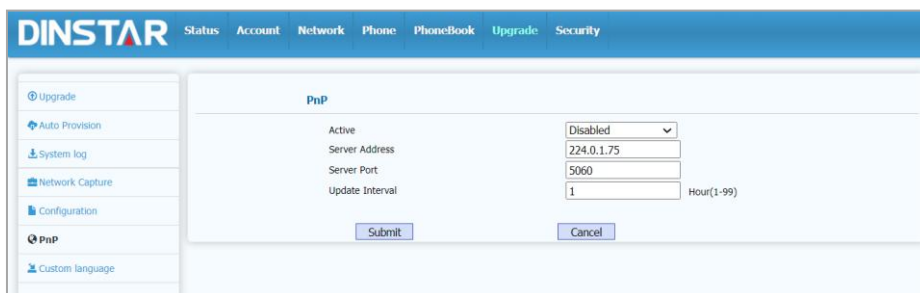

Sections	Description
PnP	<p>PnP setting for Auto Provisioning.</p> <ul style="list-style-type: none"> <li>Active: Once PNP is enabled, the phone will send SIP subscription message to PNP server automatically to get Auto Provisioning server's address. By default, this SIP message is sent to multicast address 224.0.1.75.</li> <li>Server Address: The address of the PNP server.</li> <li>Server Port: The port of the PNP server.</li> <li>Update Interval: Check whether the PNP server has an update interval.</li> </ul>

### 5.7.7 Upgrade->Custom Language

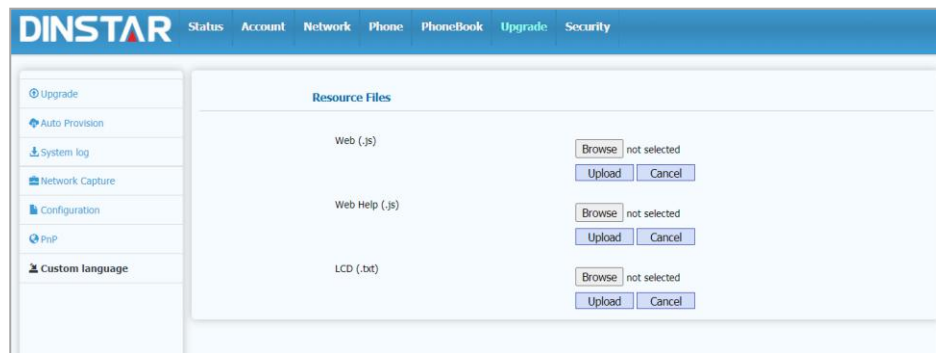

Sections	Description
Resource Files	<ul style="list-style-type: none"> <li>Web: Upload and set Web language other than help information.</li> <li>Web Help: Upload and set Web help information language.</li> <li>LCD: Upload and set the system language of the phone.</li> </ul>



## 5.8 Security

### 5.8.1 Security->Basic

The screenshot shows the DINSTAR web interface. The top navigation bar includes 'Status', 'Account', 'Network', 'Phone', 'PhoneBook', 'Upgrade', and 'Security'. The left sidebar has 'Basic' (selected), 'Advanced', and 'Firewall'. The main content area is divided into two sections:

- Web Password Modify:** Contains a dropdown menu for 'Username' (set to 'admin'), and three text input fields for 'Current Password', 'New Password', and 'Confirm Password'.
- Session Timeout:** Contains a text input field for 'Session Timeout' (set to '10000') with a range '(60~14400s)' to its right.

At the bottom of the form are 'Submit' and 'Cancel' buttons.

Sections	Description
<b>Web Password Modify</b>	<p>To modify Web password.</p> <ul style="list-style-type: none"> <li>• User Name: Select the username (administrator or user) that needs to be modified</li> <li>• Current Password: The current password you used.</li> <li>• New Password: Input new password you intend to use.</li> <li>• Confirm Password: Repeat the new password.</li> </ul>
<b>Session Timeout</b>	<p>It configures session timeout.</p> <ul style="list-style-type: none"> <li>• Session Timeout: The value specifies the timeout for login retry in seconds.</li> </ul>

## 5.8.2 Security->Advanced

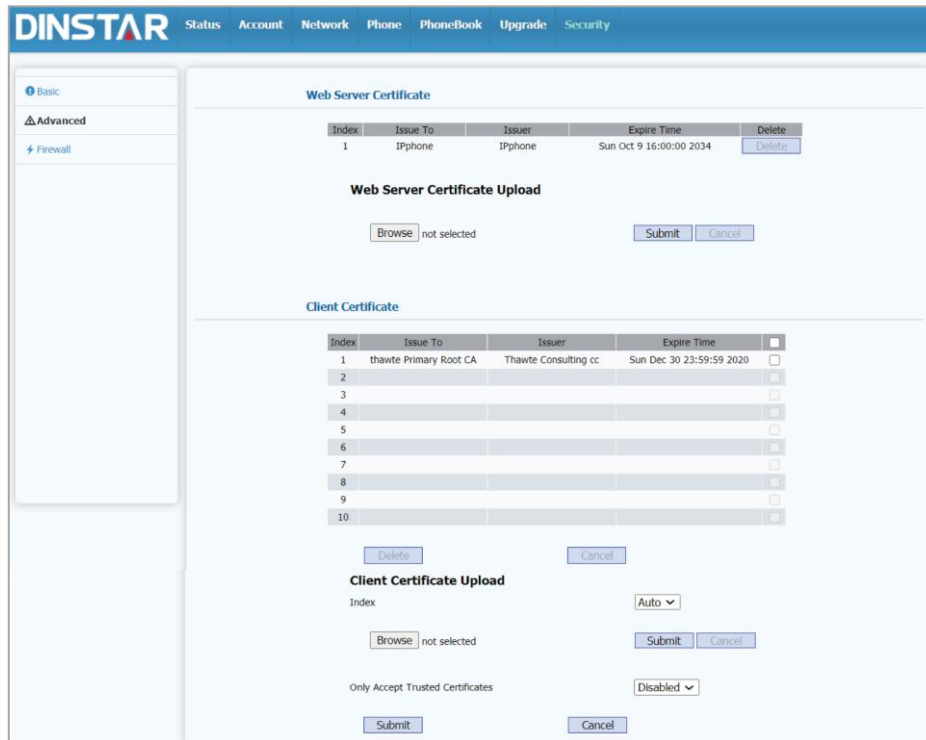

Sections	Description
<b>Web Server Certificate</b>	To display or delete Certificate which is used when IP phone is connected from any incoming HTTPs request. <b>Note:</b> The default certificate could not be deleted.
<b>Web Server Certificate Upload</b>	Upload certificate file which will be used as server certificate.
<b>Client Certificate</b>	To display or delete Certificates which is used when IP phone is connecting to any HTTPs server.
<b>Client Certificate Upload</b>	Upload certificate files which will be used as client certificate. <ul style="list-style-type: none"> <li>Only Accept trusted Certificates: If this option is enabled, only trusted certificates will be accepted.</li> </ul>

### 5.8.3 Security->Firewall

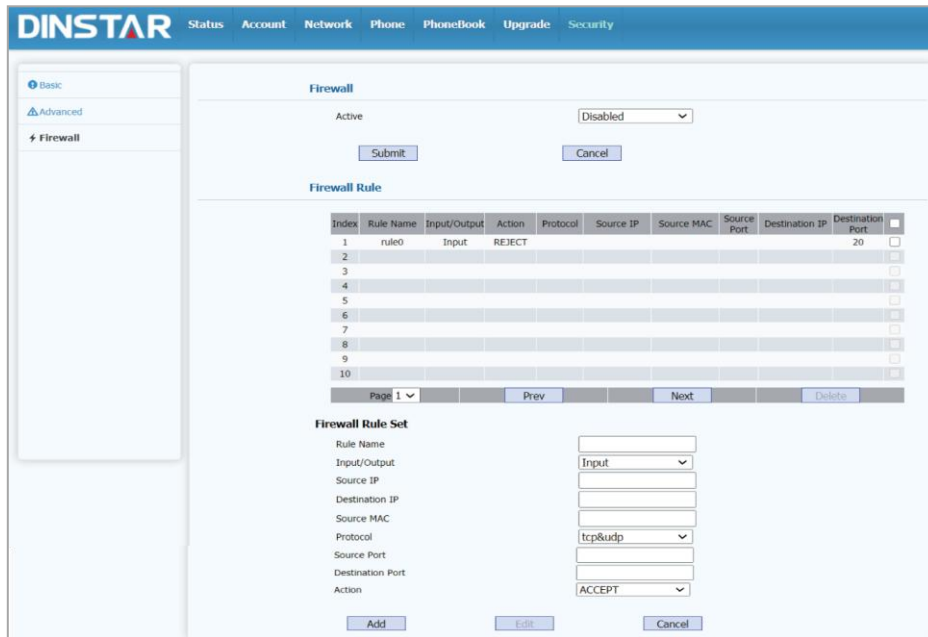

Sections	Description
<b>Firewall</b>	Active: Enable or disable firewall
<b>Firewall Rule</b>	<ul style="list-style-type: none"> <li>• Input/Output: Select the direction of the input and output of the network packet</li> <li>• Source IP: Set source IP</li> <li>• Destination IP: Set the destination IP</li> <li>• Source MAC: Set network source MAC</li> <li>• Protocol: Select the transmission protocol of the network packet</li> <li>• Source Port: Set the network source port</li> <li>• Destination Port: Set the network destination port</li> <li>• Action: To accept or reject network packets to pass</li> </ul>

# 6 Troubleshooting

---

## **Issue 1: The LCD does not light up**

- Check the AC power adapter. Make sure it is the one provided in your package.
- Check the power outlet. Make sure that the power that outlet you are plugging your device into is working. Try to plug a different device into the socket to make sure it has power.

## **Issue 2: No tone heard from the handset**

- Check the connection cord between the handset and the phone. Make sure it is connected properly.

## **Issue 3: Cannot access the web system**

- Check the connection between the PC port of the device and the network port of the computer. Make sure it is fine.
- Check whether the IP address of the device is correct.
- If it is LAN, please make sure there is no IP address conflict with other devices on the network.

## **Issue 4: Cannot call out**

- Please see the network connection status of device, if it is exception, and then check the connection of network.
- If the network connection is normal, please check whether the device has registered successfully.
- If the network connection and the registered are both normal, please confirm whether the dial rule is correct, or please communicate with the service operator.

# 7 Appendix

## 7.1 Abbreviations

Abbreviation	Explanation
ACD	Automatic Call Distribution
BLF	Busy Lamp Field
CID	Caller Identity
DND	Do NOT Disturb
DTMF	Dual Tone Multi Frequency
DNS	Domain Name System
DHCP	Dynamic Host Configuration Protocol
NAT	Network Address Translation
LDAP	Lightweight Directory Access Protocol
LLDP	Link Layer Discovery Protocol
SNMP	Simple Network Management Protocol
TR069	Technical Report - 069
NMS	Network management system
PNP	Plug-and-Play
PPPoE	point-to-point protocol over Ethernet
NTP	Network Time Protocol
RTP	Real Time Protocol
SIP	Session Initiation Protocol
TCP	Transmission Control Protocol
UDP	User Datagram Protocol
802.1X	IEEE 802.1X
VPN	Virtual Private Network
WLAN	Wireless Local Area Network

## 7.2 Time Zones

Time Zone	Time Zone Name
-11	Samoa
-10	United States-Hawaii-Aleutian
-10	United States-Alaska-Aleutian
-9	United States-Alaska Time
-8	Canada(Vancouver,Whitehorse)
-8	Mexico(Tijuana,Mexicali)
-8	United States-Pacific Time
-7	Canada(Edmonton,Calgary)
-7	Mexico(Mazatlan,Chihuahua)
-7	United States-Mountain Time
-7	United States-MST no DST
-6	Canada-Manitoba(Winnipeg)
-6	Chile(Easter Islands)
-6	Mexico(Mexico City,Acapulco)
-6	United States-Central Time
-5	Bahamas(Nassau)
-5	Canada(Montreal,Ottawa,Quebec)
-5	Cuba(Havana)
-5	United States-Eastern Time
-4:30	Venezuela(Caracas)
-4	Canada(Halifax,Saint John)
-4	Chile(Santiago)
-4	Paraguay(Asuncion)
-4	United Kingdom-Bermuda(Bermuda)
-4	United Kingdom(Falkland Islands)
-4	Trinidad&Tobago
-4	Curaçao

## Appendix

<b>Time Zone</b>	<b>Time Zone Name</b>
-3:30	Canada-New Foundland(St.Johns)
-3	Denmark-Greenland(Nuuk)
-3	Argentina(Buenos Aires)
-3	Brazil(no DST)
-3	Brazil(DST)
-2	Brazil(no DST)
-1	Portugal(Azores)
0	GMT
0	Greenland
0	Denmark-Faroe Islands(Torshaven)
0	Ireland(Dublin)0 Portugal(Lisboa,Porto,Funchal)
0	Spain-Canary Islands(Las Palmas)
0	United Kingdom(London)
0	Morocco
+1	Poland(Warsaw)
+1	Albania(Tirane)
+1	Austria(Vienna)
+1	Belgium(Brussels)
+1	Caicos
+1	Chatham
+1	Croatia(Zagreb)
+1	Czech Republic(Prague)
+1	Denmark(Copenhagen)
+1	France(Paris)
+1	Germany(Berlin)
+1	Hungary(Budapest)
+1	Italy(Rome)
+1	Luxembourg(Luxembourg)
+1	Makedonia(Skopje)

<b>Time Zone</b>	<b>Time Zone Name</b>
+1	Netherlands(Amsterdam)
+1	Namibia(Windhoek)
+2	Estonia(Tallinn)
+2	Finland(Helsinki)
+2	Gaza Strip(Gaza)
+2	Greece(Athens)
+2	Israel(Tel Aviv)
+2	Jordan(Amman)
+2	Latvia(Riga)
+2	Lebanon(Beirut)
+2	Moldova(Kishinev)
+2	Russia(Kaliningrad)
+2	Romania(Bucharest)
+2	Syria(Damascus)
+2	Turkey(Ankara)
+2	Ukraine(Kyiv,Odessa)
+3	East Africa Time
+3	Iraq(Baghdad)
+3	Russia(Moscow)
+3	30 Iran(Teheran)
+4	Armenia(Yerevan)
+4	Azerbaijan(Baku)
+4	Georgia(Tbilisi)
+4	Kazakstan(Aqtau)
+4	Russia(Samara)
+5	Kazakstan(Aqtobe)
+5	Kyrgyzstan(Bishkek)
+5	Pakistan(Islamabad)
+5	Russia(Chelyabinsk)



## Appendix

<b>Time Zone</b>	<b>Time Zone Name</b>
+5	Russia(Yekaterinburg)
+5:30	India(Calcutta)
+6	Kazakstan(Astana,Almaty)
+6	Russia(Novosibirsk,Omsk)
+7	Russia(Krasnoyarsk)
+7	Thailand(Bangkok)
+8	China(Beijing)
+8	Singapore(Singapore)
+8	Australia(Perth)
+9	Korea(Seoul)
+9	Japan(Tokyo)
+9:30	Australia(Adelaide)
+9:30	Australia(Darwin)
+10	Australia(Sydney,Melbourne,Canberra)
+10	Australia(Brisbane)
+10	Australia(Hobart)
+10	Russia(Vladivostok)
+10:30	Australia(Lord Howe Islands)
+11	New Caledonia(Noumea)
+12	New Zealand(Wellington,Auckland)
+12:45	New Zealand(Chatham Islands)
+13	Tonga(Nukualofa)
-7	United States-Mountain Time