



ULX-D

Wireless Microphone System

User guide for Shure ULXD Single wireless system. Includes setup instructions, specifications, and troubleshooting.
Version: 6.1 (2021-I)

Table of Contents

ULX-D Wireless Microphone System	4	Transmitter IR Presets	24
		Creating a System Preset	24
Quickstart Instructions	4	RF	24
General Description	5	Transmitter RF Power	25
Features	5	Interference Detection	25
Hardware Interface	6	Advanced RF	25
Receiver	6	Networking Receivers	26
Transmitters	9	Automatic IP Addressing	26
Boundary and Gooseneck Base Transmitters	11	Manual IP Addressing	26
Advanced Transmitter Features	12	Device ID	26
Menu Screens	13	High Density Mode	26
Adjusting Receiver Display Brightness and Contrast	15	System Reset	27
Home Screen Display Options	15	Firmware	27
Editing Receiver Channel Name	17	Firmware Versions	27
Setting Regional TV Format	17	Updating the Receiver	27
Locking Controls and Settings	17	Updating the Transmitter	28
Batteries	18	Managing Your System with Shure Software	28
Battery Indicator	18	Troubleshooting	28
Shure SB900 Series Rechargeable Battery	19	Power	29
Important Tips for Care and Storage of Shure Rechargeable Batteries	19	Gain	29
Installing the Battery Contact Cover	19	Cables	29
Audio	20	Interface Locks	29
Setting Receiver Gain	20	Encryption Mismatch	29
Muting a Receiver Channel Audio Output	20	Tx Battery Hot	29
Transmitter Input Clip	21	Radio Frequency (RF)	29
Audio Signal Encryption	21	Contact Customer Support	30
Scan and Sync	22	Accessories	30
Multiple System Setup	23	Furnished Accessories	30
Manual Frequency Selection	24	Optional Accessories	32

Specifications	33	IMPORTANT SAFETY INSTRUCTIONS	46
Receiver Output Level	34	WARNING	47
ULXD1	35	Important Product Information	48
ULXD2	36	LICENSING INFORMATION	48
Tables and Diagrams	37	Australia Warning for Wireless	48
Batteries	38	Certifications	48
Frequency Range and Transmitter Output Power	38	Information to the user	49
Frequencies for European Countries	40		

ULX-D Wireless Microphone System

Quickstart Instructions

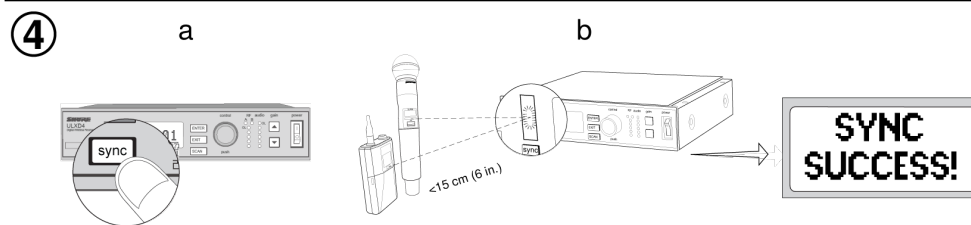
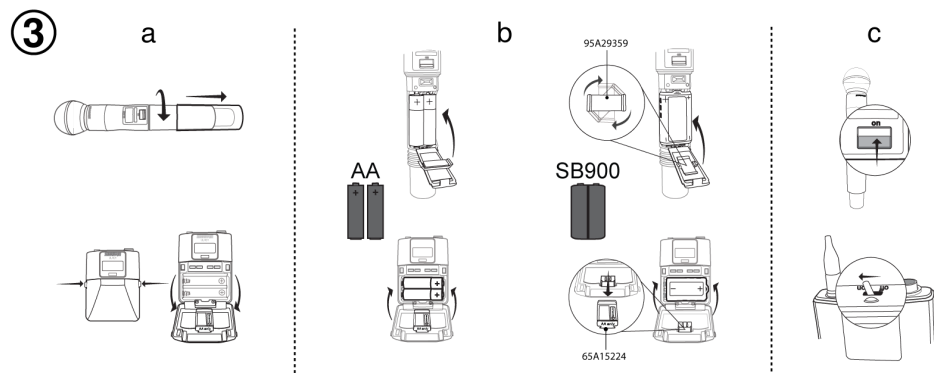
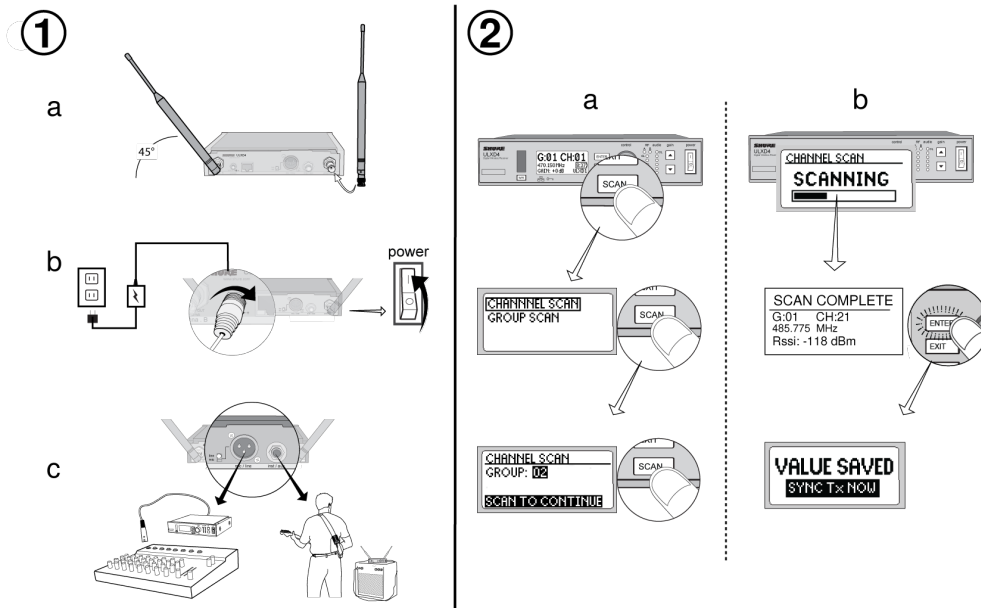

General Description

Shure ULX-D™ Digital Wireless offers uncompromising 24-bit audio quality and RF performance, with intelligent, encryption-enabled hardware, flexible receiver options, and advanced rechargeability options for professional sound reinforcement.

A breakthrough in wireless audio quality, Shure digital processing enables ULX-D to deliver the purest reproduction of source material ever available in a wireless system, with a wide selection of trusted Shure microphones to choose from. Extended 20 Hz – 20 kHz frequency range and flat response captures every detail with clarity, presence, and incredibly accurate low end and transient response. With greater than 120 dB, ULX-D delivers wide dynamic range for excellent signal-to-noise performance. Optimized for any input source, ULX-D eliminates the need for transmitter gain adjustments.

ULX-D sets a new and unprecedented standard for spectral efficiency and signal stability. The intermodulation performance of ULX-D is an incredible advancement in wireless performance, enabling a dramatic increase in the number of simultaneous active transmitters on one TV channel. Rock-solid RF signal with zero audio artifacts extends over the entire range. For applications where secure wireless transmission is required, ULX-D offers Advanced Encryption Standard (AES) 256-bit encrypted signal for unbreakable privacy.

For scalability and modular flexibility, ULX-D receivers come in single, dual, and even quad channel versions. The dual and quad channel receivers offer conveniences such as RF cascade, internal power supply, bodypack frequency diversity, audio output channel summing, and Dante™ digital networking for multi-channel audio over Ethernet. All receivers offer High-Density mode for applications where high channel counts are needed, greatly increasing the amount of simultaneous channels possible over one frequency band.

Advanced Lithium-ion rechargeability provides extended transmitter battery life over alkaline batteries, battery life metering in hours and minutes accurate to within 15 minutes, and detailed tracking of battery health status.

Generations ahead of any other available system in its class, ULX-D brings a new level of performance to professional sound reinforcement.

Features

Uncompromising Professional Digital Wireless

- 24-bit/48 KHz digital audio that exceeds all other systems in accurate reproduction of the source material
- 20 Hz – 20 KHz frequency range with flat response
- Greater than 120 dB dynamic range for excellent signal-to-noise performance
- Advanced Encryption Standard (AES-256) for any application where secure transmission is needed:
 - AES algorithm used in Shure ULX-D™ Wireless has been validated (validation no: 2552) by the National Institute of Standards and Technology (NIST) as conforming to the Advanced Encryption Standard (AES) Algorithm, as specified in Federal Information Processing Standard (FIPS) Publication 197, Advanced Encryption Standard
 - Added benefit of eliminating stray RF interference by allowing only encrypted signal through to the receiver
- Built-in limiter circuitry prevents digital audio clipping from excessive signal levels.
- 60 dB of adjustable system gain easily accessible from the receiver front panel
- No transmitter gain adjustments needed - optimized for any input source
- Wide selection of trusted Shure Microphones

Extremely Efficient and Reliable RF Performance

- Up to 64 MHz overall tuning range (region dependent)
- Minimized intermodulation distortion results in significantly more channels on air, setting the bar for wireless performance in crowded RF environments
 - 17 active transmitters in one 6 MHz TV channel
 - 22 active transmitters in one 8 MHz TV channel

- High Density mode enables up to 47 active transmitters in one 6 MHz TV channel (63 in one 8 MHz TV channel), with no audio quality degradation
- Over 60 compatible channels on one frequency band
- Rock-solid signal stability with no audio artifacts extends over the entire 100 meter line-of-sight range using standard supplied dipole antennas
- Selectable 1, 10, and 20 mW transmitter RF output power (region dependent)
- Optimized scanning automatically finds, prioritizes, and selects the cleanest frequencies available

Rugged, Intelligent Hardware

- Optimized scanning automatically finds and deploys the cleanest frequencies available
- Proprietary Shure Gain Ranging optimizes system dynamic range for any input source, eliminating the need for transmitter gain adjustments
- Up to 60 dB of adjustable system gain is easily accessible from the receiver front panel
- Networkable receiver simplifies setup across multiple channels
- Compatible with external controllers such as AMX and Creston. Cross-subnet control enabled for management between multiple facilities or venues.
- Rugged metal housing on both transmitters and receiver
- Interference detection and alerts provide instant confirmation when interference is present
- Upgraded LCD screens with adjustable contrast and brightness on both transmitters and receivers

Advanced Rechargeability - Shure Rechargeable Battery

- Lithium-Ion chemistry and intelligent Shure battery circuitry results in rechargeable batteries with no memory effect.
- The battery can be recharged at any time; a complete discharge is never necessary
- Adapted from industry-leading Axient[®] rechargeable technology
- Lithium-Ion chemistry and intelligent Shure battery circuitry results in rechargeable batteries with zero memory effect and precision metering
- AA alkaline backwards compatibility

Hardware Interface

Receiver

Front Panel

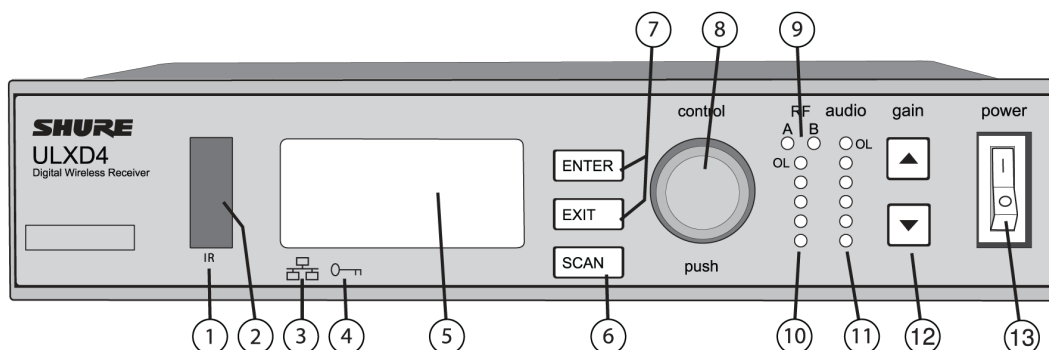

① Sync Button

Press the sync button while the receiver and transmitter IR windows are aligned to transfer settings from the receiver to the transmitter

② Infrared (IR) Sync Window

Sends IR signal to the transmitter for sync

③ Network Icon

Illuminates when the receiver is connected with other Shure devices on the network. IP Address must be valid to enable networked control

④ Encryption Icon

Illuminates when AES-256 encryption is activated: **Utilities > Encryption**

Note: Encryption is not configurable for all units.

⑤ LCD Panel

Displays settings and parameters

⑥ Scan Button

Press to find the best channel or group

⑦ Menu Navigation Buttons

Use to select and navigate through parameter menus

⑧ Control Wheel

Push to select menu items for editing, turn to edit a parameter value

⑨ RF Diversity LEDs

Indicate antenna status:

- Blue = normal RF signal between the receiver and transmitter
- Red = interference detected
- Off = No RF connection between the receiver and transmitter

Note: the receiver will not output audio unless one blue LED is illuminated

⑩ RF Signal Strength LEDs

Indicate the RF signal strength from the transmitter:

- Amber = Normal (-90 to -70 dBm)
- Red = Overload (greater than -25 dBm)

⑪ Audio LEDs

Indicate average and peak audio levels:

LED	Audio Signal Level	Description
Red (6)	-0.1 dBFS	Overload/ limiter

LED	Audio Signal Level	Description
Yellow (5)	-6 dBFS	Normal peaks
Yellow (4)	-12 dBFS	
Green (3)	-20 dBFS	Signal Present
Green (2)	-30 dBFS	
Green (1)	-40 dBFS	

⑫ Gain Buttons

Adjust channel gain

⑬ Power Switch

Powers the unit on or off

Back Panel

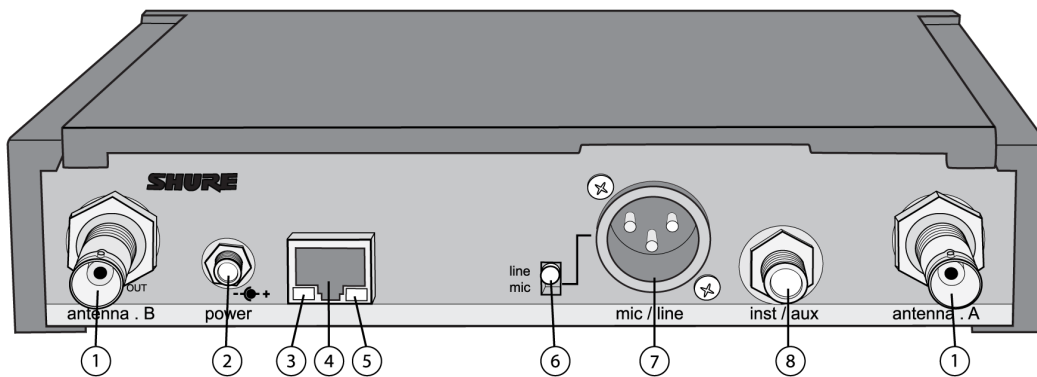

① RF Antenna Diversity Input Jack (2)

For antenna A and antenna B.

② Power Supply Jack

Connect the supplied 15 V DC external power supply

③ Network Speed LED (Amber)

- Off = 10 Mbps
- On = 100 Mbps

④ Ethernet Port

Connect to an Ethernet network to enable remote control and monitoring

Note: Use shielded Cat5e or better Ethernet cables for VHF (V50 and V51) to ensure reliable network performance.

⑤ Network Status LED (Green)

- Off = no network link
- On = network link active
- Flashing = network link active, flash rate corresponds to traffic volume

⑥ Mic/Line Switch

Applies a 30 dB pad in mic position (XLR output only)

⑦ Balanced XLR Audio Output

Connect to a mic or line level input

⑧ Balanced 1/4" (6.35 mm) TRS Audio Output

Connect to a mic or line level input

Transmitters

① Power LED

- Green = unit is powered on
- Red = low battery or battery error (see Troubleshooting)
- Amber = power switch is disabled

② On/Off Switch

Powers the unit on or off.

③ SMA Connector

Connection point for RF antenna.

④ LCD Display:

View menu screens and settings. Press any control button to activate the backlight.

⑤ Infrared (IR) Port

Align with the receiver IR port during an IR sync for automated transmitter programming.

⑥ Menu Navigation Buttons

Use to move through parameter menus and change values.

exit	Acts as a 'back' button to return to previous menus or parameters without confirming a value change
enter	Enters menu screens and confirms parameter changes
▼ ▲	Use to scroll through menu screens and to change parameter values

⑦ Battery Compartment

Requires Shure rechargeable battery or 2 AA batteries.

⑧ AA Battery Adapter

- Handheld: rotate and store in the battery compartment to use a Shure rechargeable battery
- Bodypack: remove to accommodate a Shure rechargeable battery

⑨ Bodypack Antenna

For RF signal transmission.

⑩ Integrated Antenna

For RF signal transmission.

⑪ Microphone Cartridge

See Optional Accessories for a list of compatible cartridges.

⑫ TA4M / LEMO Input Jack

Connects to a microphone or instrument cable.

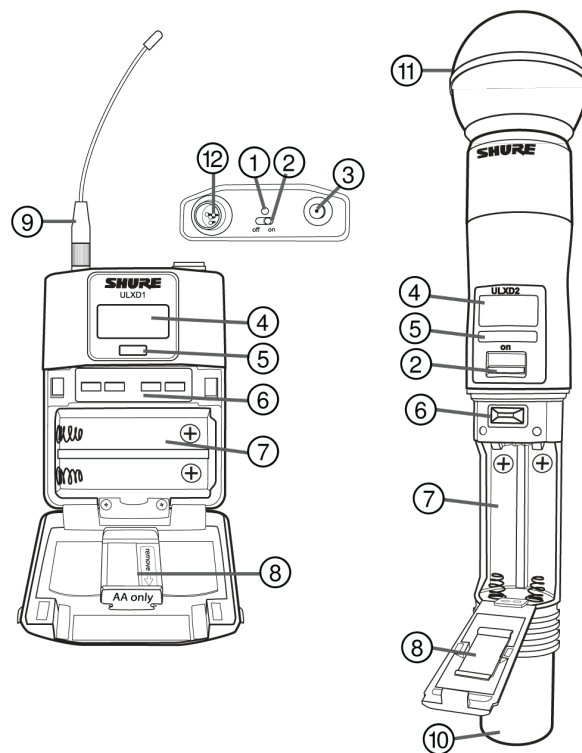

Boundary and Gooseneck Base Transmitters

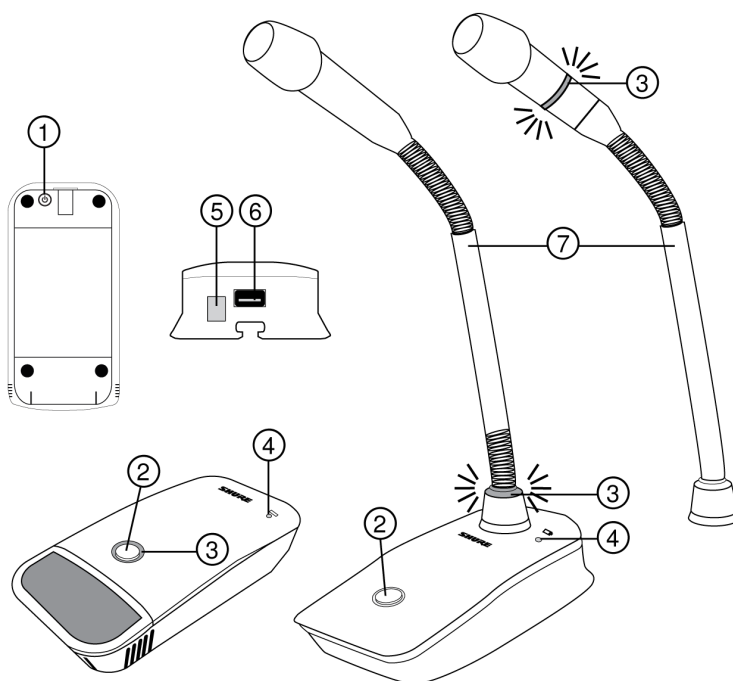

① Power Button

Press to power on; press and hold to power off.

② Mute/Active Button

Four settings are available for the mute/active button:

- Toggle: Press to switch between active and mute states
- Push-to-Mute: Hold button to mute microphone
- Push-to-Talk: Hold button to activate microphone
- Disabled: Button functionality off

③ Mute LED

Indicates whether microphone is active or muted. The following settings are available:

Active	Muted
Green*	Red*
Red	Off
Red	Flashing red

*MX400R series gooseneck microphones (red LED) do not offer this setting.

④ Low-Battery LED

- Off = More than 30 minutes of battery life remain
- On (red) = Less than 30 minutes of battery life remain

- On (green) = Microphone docked on charging station
- On (amber) = Battery is missing or is not inserted correctly

⑤ Infrared (IR) Port

Align with receiver IR port to send settings to transmitter.

⑥ Charge Connector

Connects to networked chargers and USB power supply.

⑦ Gooseneck Microphone

ULXD8 base fits 5", 10", and 15" Microflex series microphones, available in single or dualflex and with bi-color or red-only LEDs.

Advanced Transmitter Features

RF MUTE

Use this to turn on a transmitter without interfering with the RF spectrum.

Press and hold exit during power-on until RF MUTED is displayed. To un-mute, restart the transmitter.



MIC.OFFSET

MIC.OFFSET compensates for signal level differences between transmitters that share the same receiver channel.

Set the offset gain on a low signal level transmitter to match a louder transmitter: UTILITY > MIC . OFFSET

Note: For normal gain adjustments, use the receiver gain buttons.

Transmitter Audio Mute Mode

Mute Mode reconfigures the transmitter power switch to act a mute switch for the audio. Using the switch, the audio can be easily turned on or muted by presenters, sports referees, or anyone who periodically needs to speak. When the audio is muted, the transmitter RF signal remains on and ready at all times.

Note: Mute Mode can be selected as an IR PRESET option.

To set a transmitter to Mute Mode:

1. From the transmitter menu: UTILITY > MUTE MODE
2. Use the arrows to select ON or OFF.
3. Press enter to save.

Tip: The transmitter LED turns red when audio is muted and turns green when audio is enabled. The display of the transmitter will show AUDIO MUTED and the receiver display will show Tx Muted.

Note: Mute Mode must be set to OFF in order to use the power switch to turn off the transmitter.

Menu Screens

Receiver Channel

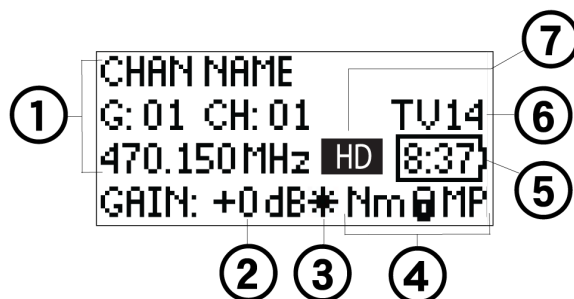

① Receiver Information

Use DEVICE UTILITIES > HOME INFO to change the home screen display.

② Gain Setting

-18 to +42 dB, or Mute.

③ Mic. Offset Indicator

Indicates offset gain is added to the transmitter.

④ Transmitter Settings

The following information cycles when a transmitter is tuned to the receiver's frequency:

- Transmitter Type
- Input Pad (Bodypack only)
- RF Power Level
- Transmitter Lock Status
- Transmitter Mute Status

⑤ Battery Runtime Indicator

Shure rechargeable battery: runtime is displayed in minutes remaining.

AA batteries: runtime is displayed with a 5-bar indicator.

⑥ TV Channel



Displays the TV channel that contains the tuned frequency.

⑦ High Density Mode Icon

Displayed when High Density mode is enabled.

Transmitter Status

The following text or icons report transmitter status to the receiver screen:

Display Icon	Transmitter Status
	Bodypack input is attenuated 12 dB
	Offset gain is added to the transmitter
Lo	1 mW RF power level
Nm	10 mW RF power level
Hi	20 mW RF power level
M	Menu is locked
P	Power is locked
TxMuted	Displayed when the transmitter audio is set to off using the MUTE MODE feature
-No Tx-	No RF connection between a receiver and transmitter or transmitter OFF

Transmitter

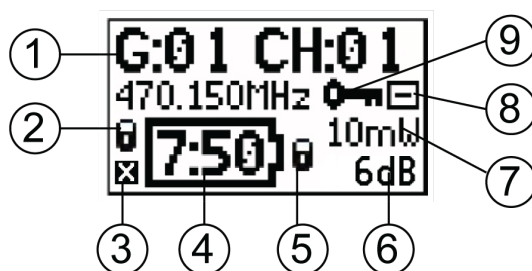

① Transmitter Information

Scroll ▲ ▼ at the home screen to change the display

② Power Lock Indicator

Indicates power switch is disabled

③ Transmitter Audio Muted Indicator

Displayed when the transmitter audio is set to off using the MUTE MODE feature.

④ Battery Runtime Indicator

- Shure rechargeable battery: runtime is displayed in hours:minutes remaining
- AA Batteries: runtime is displayed with a 5-bar indicator

⑤ Menu Lock Indicator

Indicates menu navigation buttons are disabled

⑥ Mic. Offset

Displays microphone offset gain value

⑦ RF Power

Displays RF power setting

⑧ Bodypack Input Pad

The input signal is attenuated 12 dB

⑨ Encryption Icon

Indicates encryption is enabled on the receiver and has been transferred to the transmitter from a sync

Adjusting Receiver Display Brightness and Contrast

Adjust BRIGHTNESS and CONTRAST settings to improve visibility in challenging lighting environments.

1. From the receiver menu: DEVICE UTILITIES > DISPLAY
2. Press the control wheel to select CONTRAST or BRIGHTNESS.
3. Turn the control to adjust the selected parameter.
4. Press ENTER to save changes.

Home Screen Display Options

Receiver

The HOME INFO menu provides options to change the information shown on the receiver home screen:

DEVICE UTILITIES > HOME INFO

Use the control wheel to select one of the following screen displays.

CHANNAME
470.150MHz 8:37
+10dB ULXD1

Receiver home screen view 1

470.150MHz
G: 01 CH: 01
GAIN: +0dB No Tx

Receiver home screen view 2

G:01 CH:01
 470.150MHz 8:37
 GAIN: +0dB ULXD1

Receiver home screen view 3

Transmitter

Home Screen: Press the ▲ ▼ arrows at the home menu to display one of the following screens:

CHAN NAME
 470.150 MHz
 7:50 10mW

Transmitter home screen view 1

G:01 CH:01
 470.150MHz =
 7:50 10mW
 12dB

Transmitter home screen view 2

470.150MHz
 G:01 CH:01
 7:50 10mW

Transmitter home screen view 3

Editing Receiver Channel Name

To edit a receiver channel name, choose EDIT NAME from the menu.

- Turn the control wheel to edit a highlighted character
- Press the control wheel to advance to the next character
- Press ENTER to save changes

Note: The channel name is transferred to a transmitter during a sync.

Setting Regional TV Format

To ensure accurate display of TV channel information, set the TV FORMAT to match the TV channel bandwidth in the region where the receiver is operating. TV bandwidth varies globally, so check local regulations to determine the regional TV bandwidth.

The following TV FORMAT options are available:

- 6 MHz
- 7 MHz
- 8 MHz
- 6 MHz JAPAN
- NO TV (use to turn off TV channel display or in regions where TV channels are not applicable)

To set the TV FORMAT:

1. Menu: DEVICE UTILITIES > ADVANCED RF > TV FORMAT
2. Use the control wheel to select a TV FORMAT option.
3. Press ENTER to save.

Locking Controls and Settings



Use the LOCK feature to prevent accidental or unauthorized changes to the hardware. Attempting to access a locked feature will display the following message:

Receiver

Menu path: UTILITIES > LOCK

MENU: All menu paths are inaccessible. To unlock, press the EXIT button, turn the control wheel to select UNLOCKED and press ENTER to save.

GAIN: Gain adjustment is locked

POWER: Power switch is disabled

SCAN: Cannot perform a group scan

SYNC: Cannot sync devices

Transmitter

Menu path: UTILITY > LOCK

MENU: All menu paths are inaccessible. To unlock, press the ENTER button four (4) times to pass through the following screens: UTILITY > LOCK > MENU UNLOCK

POWER: Power switch is disabled

Quick-Lock Option: To turn on the transmitter with its power and menu navigation buttons locked, press and hold the ▲ button during power-on until the locked message is displayed.

To unlock, turn the power switch to the off position, then press and hold the ▲ button while turning the power switch to the on position.

Batteries

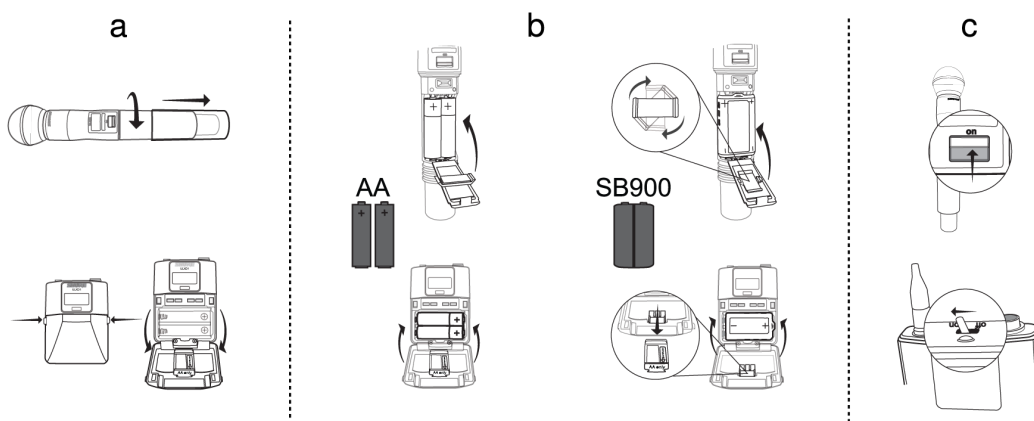

The transmitter runs on two AA batteries or a Shure SB900 series rechargeable battery. Use the included AA battery adapter when using batteries other than the Shure rechargeable battery.

Bodypack: Remove the adapter when using the Shure rechargeable battery

Handheld: Rotate and store the adapter in battery door when using Shure rechargeable battery

Battery Indicator





A 5-segment icon on the receiver and transmitter menu screens indicates battery charge.

For accurate battery runtime monitoring, set the transmitter to the appropriate battery type: UTILITY > BATTERY > SET . AA . TYPE.

This table displays the approximate hours and minutes remaining (h:mm).

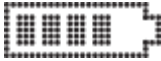
Alkaline

Battery Indicator	UHF/VHF		ISM/1.x	
	1/10 mW	20 mW	1/10mW	20mW
	9:00 to 6:30	5:45 to 4:15	7:30 to 5:30	5:30 to 4:00

Battery Indicator	UHF/VHF		ISM/1.x	
	1/10 mW	20 mW	1/10mW	20mW
	6:30 to 4:00	4:15 to 3:00	5:30 to 3:30	4:00 to 2:45
	4:00 to 1:45	3:00 to 1:30	3:30 to 1:45	2:45 to 1:30
	1:45 to 0:45	1:30 to 0:30	1:45 to 0:45	1:30 to 0:30
	<0:45	<0:30	<0:45	<0:30
	Replace	Replace	Replace	Replace

Shure SB900 Series Rechargeable Battery

When using a Shure rechargeable battery, the receiver and transmitter home screens display the number of hours and minutes remaining.

Detailed information for the rechargeable battery is displayed in the receiver BATTERY INFO menu and the transmitter menu: UTILITY > BATTERY > BATT. STATS

HEALTH: Displays battery health as a percentage of the charge capacity of a new battery.

CHARGE: Percentage of a full charge

CYCLES: Number of times the battery has been charged

TEMP: Battery temperature in Celsius and Fahrenheit

Note: For additional rechargeable battery information, visit www.shure.com.

```

HEALTH: 90%
CHARGE: 80%
CYCLES: 100
TEMP: 10°C / 50°F

```

Important Tips for Care and Storage of Shure Rechargeable Batteries

Proper care and storage of Shure batteries results in reliable performance and ensures a long lifetime.

- Always store batteries and transmitters at room temperature
- Ideally, batteries should be charged to approximately 40% of capacity for long-term storage
- During storage, check batteries every 6 months and recharge to 40% of capacity as needed

Installing the Battery Contact Cover

Install the included battery contact cover (65A15947) on the handheld transmitter to prevent light reflection in broadcast and performance situations.

1. Align the cover as shown.
2. Slide the cover over the battery contacts until it is flush with the transmitter body.

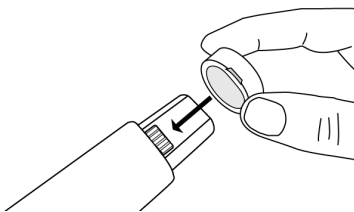

Note: Slide the cover off before inserting the transmitter in the battery charger.

Audio

Setting Receiver Gain

The receiver gain control sets the audio signal level for the entire receiver and transmitter system. Changes to the gain settings occur in realtime allowing for adjustments during live performances. When adjusting the gain, monitor the audio meter levels to prevent signal overloads.

Receiver Gain Controls

The gain can be adjusted by using the gain ▲ ▼ buttons or by entering the AUDIO menu and using the control wheel.

Tip: To quickly adjust the gain, press and hold a gain button to enable accelerated scrolling.

Reading the Audio Meter



The audio meter displays yellow, green, and red LEDs to indicate the audio signal level. Audio peaks illuminate the LEDs for 2 seconds, while the RMS signal is displayed in realtime.

When setting up the receiver, adjust the gain so that the average signal LED levels are solid green and occasionally yellow, with only the highest peaks causing the red LED to illuminate.

Tip: If a vocalist is overloading a bodypack transmitter, try lowering the receiver gain. If additional attenuation is needed, use the transmitter menu to set the INPUT PAD to -12dB.

Note: Illumination of the red OL (overload) LED indicates the internal limiter is engaged to prevent digital clipping.

Muting a Receiver Channel Audio Output

The audio output of each receiver channel can be independently muted to prevent audio from passing. Mute status is indicated by Rx MUTED message appearing on the receiver display in place of the gain value.

Note: Receiver gain is disabled for muted channels to prevent unexpected changes in audio levels.

To set a receiver channel output to mute:

1. AUDIO > MUTE
2. Use the control wheel to select ON or OFF.
3. Press ENTER to save.

To unmute the receiver output:

Simultaneously press the ▲ ▼ buttons or select OFF from the MUTE menu option.

Tip: Audio mute can be enabled remotely from Wireless Workbench or from an external controller.

Important! A power cycle will reset the receiver and unmute the audio output.

Transmitter Input Clip

The following warning displays on the receiver LCD panel when the transmitter input is clipped:

A black rectangular box with the text "Tx OVERLOAD" in white, bold, sans-serif font.

To correct, select INPUT PAD from the main menu and attenuate the input signal by 12 dB. If the warning persists, reduce the level of input signal.

Audio Signal Encryption

When encryption is enabled, the receiver generates a unique encryption key which is shared with a the transmitter during an IR sync. Transmitters and receivers that share an encryption key form a protected audio path, preventing unauthorized access from other receivers.

Note: For some units, encryption is always on and cannot be configured.

Encrypting a Single Transmitter to a Single Receiver

1. From the receiver menu: DEVICE UTILITIES > ENCRYPTION > ON (Auto)
2. Press ENTER.
3. Perform an IR Sync to share the encryption key with the selected transmitter.

Encrypting Multiple Transmitters to a Single Receiver

Multiple transmitters can share the same encryption key, allowing them access to a single receiver. Use this method if you have multiple instruments or wish to use a combination of handheld and bodypack transmitters.

1. From the receiver menu: DEVICE UTILITIES > ENCRYPTION > ON (Manual) > KEEP KEYS.
2. Press ENTER.
3. Perform an IR Sync to share the encryption key with the first transmitter.
4. Turn off the transmitter and perform an IR Sync to share the key additional transmitters.

Caution! Make sure only one transmitter is turned on during an IR sync or a performance to avoid causing cross interference between transmitters.

Regenerating Encryption Keys

Periodically regenerating the encryption key maintains security for transmitters and receivers that are paired for extended periods.

1. From the receiver menu: DEVICE UTILITIES > ENCRYPTION > ON (Manual) > REGENERATE KEYS.
2. Press ENTER.
3. Perform an IR Sync to share the encryption key with the first transmitter.
4. Turn off the transmitter and perform an IR Sync to share the key additional transmitters.

Caution! Make sure only one transmitter is turned on during an IR sync or a performance to avoid causing cross interference between transmitters.

Removing Encryption

Note: For some units, encryption is always on and cannot be configured.

1. From the receiver menu: DEVICE UTILITIES ENCRYPTION OFF
2. Press ENTER.
3. IR Sync the transmitter and receiver to clear the encryption key.

Note: If multiple transmitters are encrypted to a single receiver, each transmitter must be IR synced to clear the encryption key.

Scan and Sync

Use this procedure to tune a receiver and transmitter to the best open channel.

Important! Before you begin:

Turn off all transmitters to prevent them from interfering with the frequency scan.

Turn on any devices that might produce interference during the show so the scan can detect and avoid them, including:

- Other wireless systems or devices
- Computers
- CD players
- Large LED panels
- Effects processors

1. Perform a group scan on the receiver: SCAN > GROUP SCAN.
2. Press SCAN. While the scan is running, SCANNING appears on the screen.
3. When the scan is done, the receiver displays the group with the most available frequencies. Press the flashing ENTER button to deploy frequencies to each receiver channel.
4. Power on the ULXD transmitter.
5. Press the sync button on the receiver.
6. Align the IR windows until the receiver IR port turns red.

Note: When complete, SYNC SUCCESS! appears. The transmitter and receiver are now tuned to the same frequency.

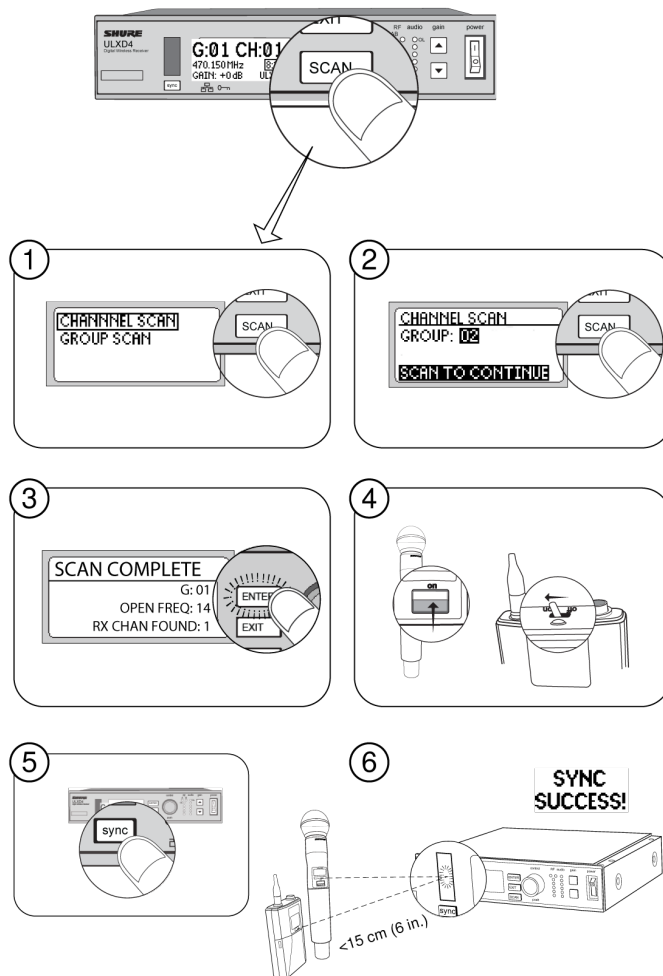

Multiple System Setup

A setup using networked receivers is the fastest and easiest way to distribute the best open channel to each system. See Networking ULX-D Receivers for networking details.

Note: Networked receivers must all be within the same frequency band.

Networked Receivers

1. Turn on all receivers.
2. Conduct a group scan on the first receiver to find available frequencies in each group: SCAN > GROUP SCAN.
3. Press ENTER to accept the group number and automatically assign the next best channel to each receiver on the network. The receiver LEDs will flash when a frequency has been assigned.
4. Turn on a transmitter and sync to the receiver.

Important! Leave the transmitter on and repeat this step for each additional system.

Non-networked Receivers

1. Turn on all receivers.
2. Conduct a group scan on the first receiver to find available frequencies in each group: SCAN > SCAN > GROUP SCAN > SCAN

3. When the scan is complete, use the control wheel to scroll through each group. Press ENTER to select a group that has enough available frequencies for all channels in the system.
4. Sync a transmitter to each receiver channel.

Important! Leave all transmitters on use the following steps to set up additional receiver channels:

1. Set each additional receiver channel to the same group as the first receiver: RADIO > G :
2. Conduct a channel scan to find available frequencies within the group: SCAN > SCAN > CHANNEL SCAN > SCAN
3. When the scan is complete, press ENTER to assign frequencies to each receiver channel.
4. Sync a transmitter to each receiver channel.

Manual Frequency Selection

To manually adjust group, channel or frequency:

1. Select Radio Frequency from the receiver menu.
2. Use the control knob to select and adjust the group (G), channel (Ch), or frequency (MHz).
3. Press ENTER to save.

Transmitter IR Presets

Use the IR PRESETS receiver menu to quickly configure transmitter settings from the receiver screen. When a sync is performed between the receiver and transmitter, the IR PRESETS automatically configure the transmitter. Each parameter has the default value KEEP, which leaves that setting unaffected by a sync.

Feature	Setting
BP PAD	+0 dB, -12 dB
LOCK	Power, Menu, All, None
RF POWER	10mW=Nm (normal), 1mW=Lo (low), 20mW=Hi (high)
BATT	Alkaline, NiMH, Lithium
BP OFFSET	0 dB to +21 dB (in 3 dB increments)
HH OFFSET	0 dB to +21 dB (in 3 dB increments)
MUTE MODE	OFF, ON
Cust. Group	OFF, ON

Note: When Cust. Groups is set to on, it may take up to 30 seconds to complete an IR sync.

Creating a System Preset

System Presets allow a current receiver setup to be saved and restored. Presets store all receiver settings to provide a quick way to configure a receiver or switch between several different setups. Up to 4 presets can be stored in receiver memory.

To save the current receiver setup as a new preset: DEVICE UTILITIES > SYSTEM RESET > SAVE > CREATE NEW PRESET

Use the control wheel to name the preset, and then press Enter to save.

To recall a saved preset: DEVICE UTILITIES > SYSTEM RESET > RESTORE

Use the control wheel to select the preset name, and then press Enter.

RF

Transmitter RF Power

Reference the following table for setting RF Power:

RF Power Setting	System Range	Application
1 mW	33 m (100 ft.)	For increased channel reuse at close distances
10 mW	100 m (330 ft.)	Typical setups
20 mW	>100 m (330 ft.)	For hostile RF environments or long-distance applications

Note: Using the 20 mW setting decreases the transmitter battery runtime and reduces the number of compatible systems.

Interference Detection



Interference Detection monitors the RF environment for potential sources of interference which can cause audio dropouts.

When interference is identified, the RF LEDs illuminate red and the following warning displays on the receiver LCD panel.

If the warning display persists or the audio drops out repeatedly, perform a Scan and Sync at the first opportunity to find a clear frequency.

Advanced RF

RF Mute



Use this to turn on a transmitter without interfering with the RF spectrum.

Press and hold the exit button during power-on until RF MUTED is displayed. To un-mute, restart the transmitter.

Custom Groups

Use this feature to create up to six groups of manually selected frequencies that can be exported to networked receivers to simplify system setup.

To create a custom group: UTILITIES > ADVANCED RF > CUSTOM GROUPS

Note: Use Wireless Workbench or Wireless Frequency Finder to select the best compatible frequencies. See www.shure.com for more information.

To export a custom group:

1. Go to UTILITIES > ADVANCED RF > CUSTOM GROUPS > EXPORT. The following screen will display.
2. Press the flashing ENTER button to export all custom groups to all receivers on the network.

Antenna Bias

Antenna ports A and B provide a DC bias to power active antennas. Set the DC power to off when using passive (non-powered) antennas.

To turn bias off: DEVICE UTILITIES > ADVANCED RF > ANTENNA BIAS > OFF

Networking Receivers

The receiver uses an Ethernet connection to network with other components. For automatic network configuration, use a DHCP enabled Ethernet switch such as the Shure AXT620. Use multiple Ethernet switches to extend the network for larger installations.

Note: Note use only one DHCP server per network.

Automatic IP Addressing

Set the IP Mode to Automatic for all receivers: DEVICE UTILITIES > NETWORK > CTRL NETWORK

Manual IP Addressing

1. Connect the receivers to an Ethernet switch.
2. Set the IP Mode to Manual for all devices (DEVICE UTILITIES > NETWORK > CTRL NETWORK)
3. Set valid IP addresses for all devices.
4. Set the subnet mask to the same value for all devices.

Device ID

Set the receiver Device ID for easy identification within the network or in Wireless Workbench: DEVICE UTILITIES > NETWORK > SHURE CONTROL > Dev . ID

Use the control wheel to edit the device ID.

High Density Mode

High Density mode creates additional bandwidth for more channels in crowded RF environments. Frequency efficiency is optimized by running at 1 mW RF transmit power and narrowing the modulation bandwidth, allowing for the channel spacing to be reduced from 350 kHz to 125 kHz. Transmitters can be positioned on adjacent channels with unsubstantial intermodulation distortion (IMD).

High Density mode is ideal for applications where many channels are needed in a confined area, transmission distances are short, and the number of available frequencies is limited. Up to 30 meters of range is available in High Density mode.

Setting the Receiver to High Density Mode

To set the receiver to High Density mode:

DEVICE UTILITIES > ADVANCED RF > HIGH DENSITY

Use the control wheel to set HIGH DENSITY to ON.

When prompted, sync the transmitter and receiver to enable HIGH DENSITY mode.

Note: When the receiver is in HIGH DENSITY mode, the following indicators are shown on the receiver display:

- The HD icon will appear on the receiver display
- The receiver band name will be shown with an "HD" added. (example: The G50 band will appear as G50HD)
- The transmitter group and channel are assigned letters instead of numbers (example: G:AA CH:AA)

Best Practices for High Density Mode

- When band planning, position ULX-D High Density channels in a range of frequencies separated from other devices.
- Use a separate RF zone for ULX-D High Density channels to prevent intermodulation distortion from other devices.
- During High Density channel scanning, turn on all other transmitters and move them to their intended position.
- Perform a walk test to verify transmitter range
- If using custom groups, the groups loaded into the receiver must be compatible with High Density mode

System Reset

System Reset clears the current receiver settings and restores the factory default settings.

To restore factory default settings:

1. Go to DEVICE UTILITIES > SYSTEM RESET > RESTORE.
2. Scroll to the DEFAULT SETTINGS option and press ENTER.
3. Press the flashing ENTER button to return the receiver to the default settings.

Firmware

Firmware is embedded software in each component that controls functionality. Periodically, new versions of firmware are developed to incorporate additional features and enhancements. To take advantage of design improvements, new versions of the firmware can be uploaded and installed using the Shure Update Utility tool available on the [Shure Update Utility page](#).

Firmware Versions

When updating receiver firmware, update transmitters to the same firmware version to ensure consistent operation.

The firmware of all ULX-D devices has the form of MAJOR.MINOR.PATCH (e.g., 1.2.14). At a minimum, all ULX-D devices on the network (including transmitters), must have the same MAJOR and MINOR firmware version numbers (e.g., 1.2.x).

Updating the Receiver

CAUTION! Ensure that receiver power and network connections are maintained during a firmware update. Do not turn off the receiver until the update is complete.

Once the download is complete, the receiver automatically begins the firmware update, which overwrites the existing firmware.

1. Open the Shure Update Utility.
2. Click the update button (for example, 5 Updates Available) to view new firmware versions available to download.
3. Select the updates and click Download. The new downloads are added to the Firmware tab, making them available to install on the device hardware.
4. Connect the receiver and computer to the same network.
5. From the Update Devices tab, download the latest firmware to the receiver.

For more information on the Shure Update Utility, visit the [Shure Update Utility user guide](#).

Updating the Transmitter

1. To upload the firmware to the transmitter, go to DEVICE UTILITIES > TX FW UPDATE on the receiver.
2. Place the transmitter on its side and align the IR ports.
3. Press ENTER on the receiver to begin the download to the transmitter. IR ports must be aligned for the entire download, which can take 50 seconds or longer.

Managing Your System with Shure Software

Wireless Workbench[®]

Manage every facet of wireless system performance, from pre-show planning to live channel monitoring, with Wireless Workbench.

- Visit [the Wireless Workbench page](#) to download Workbench.
- Visit [the Workbench help page](#) to learn how to use Workbench with your system.

ShurePlus[™] Channels Application

Monitor the key elements of your wireless operation on a mobile device over Wi-Fi with ShurePlus Channels. Use alongside Wireless Workbench or as a stand-alone application for less complex coordination needs.

- Visit [the Channels page](#) to download ShurePlus Channels.
- Visit [the Channels user guide](#) to learn how to use Channels with your system.

Troubleshooting

Issue	See Solution...
No sound	Power, Cables, or RF
Faint sound or distortion	Gain
Lack of range, unwanted noise bursts, or dropouts	RF
Cannot turn transmitter off or change frequency settings, or can't program receiver	Interface locks
Encryption error message	Encryption Mismatch

Issue	See Solution...
Transmitter battery hot message	Tx Battery hot

Power

Make sure that the receiver and transmitter are receiving sufficient voltage. Use the 15 V DC power supply furnished with the ULXD4 receiver. Check the battery indicators and replace the transmitter batteries if necessary.

Gain

Adjust the system gain on the front of the receiver. Ensure the output level (XLR output only) on the back of the receiver corresponds to the input of the mixing console, amplifier, or DSP.

Cables

Check that all cables and connectors are working correctly.

Interface Locks

The transmitter and the receiver can be locked to prevent accidental or unauthorized changes. A locked feature or button will produce the Locked screen on the LCD panel.

Encryption Mismatch

Re-sync the receiver and transmitter after enabling or disabling encryption.

Note: Encryption is not configurable for all units.

Tx Battery Hot

If the transmitter battery does not cool off, the transmitter will shut down. Let the device cool down and then consider swapping the transmitter battery to continue operation. Identify any possible external heat sources to the transmitter and operate the transmitter away from those external heat sources. All batteries should be stored and operated away from external heat sources in reasonable temperature conditions for best performance.

Radio Frequency (RF)

RF LEDs

If neither blue RF Diversity LED is illuminated, then the receiver is not detecting the presence of a transmitter.

The amber RF Signal Strength LEDs indicate the amount of signal being received. This signal could be from the transmitter, **or it could be from an interfering source, such as a television broadcast.** If more than one or two of the amber RF LEDs are still illuminated while the transmitter is off, then that channel has too much interference, and you should try a different channel.

The red RF LED indicates RF overload. This will usually not cause a problem unless you are using more than one system at the same time, in which case, it can cause interference **in the other system.**

Compatibility

- Perform a Scan and Sync to ensure the transmitter and receiver are set to the same group and channel.
- Look at the label on the transmitter and receiver to make sure they are in the same band (G50, J50, L50, etc...).

Reducing Interference

- Perform a group or channel scan to find the best open frequency. Perform a sync to transfer the setting to the transmitter.
- For multiple systems, check that all systems are set to channels in the same group (systems in different bands do not need to be set to the same group).
- Maintain a line of sight between transmitter and receiver antennas.
- Move receiver antennas away from metal objects or other sources of RF interference (such as CD players, computers, digital effects, network switches, network cables and Personal Stereo Monitor (PSM) wireless systems).
- Eliminate RF overload (see below).

Increasing Range

If the transmitter is more than 6 to 60 m (20 to 200 ft) from the receiver antenna, you may be able to increase range by doing one of the following:

- Reduce interference (see above).
- Increase transmitter RF power level.
- Use an active directional antenna, antenna distribution system, or other antenna accessory to increase RF range.

Eliminating RF Overload

If you see the red RF LED on a receiver, try the following:

- Reduce the transmitter RF power level
- Move the transmitter further away from the receiver—at least 6 m (20 ft)
- If you are using active antennas, reduce antenna or amplifier gain.
- Use omnidirectional antennas

Contact Customer Support

Didn't find what you need? [Contact our customer support](#) to get help.

Accessories

Furnished Accessories

All Systems

Receiver	ULXD4
Power Supply	PS43
1/2-Wave Receiver Antennas (2)	95T9279
22 in. BNC-BNC Coaxial Cable (2)	95K2035
Bulkhead Adapter (2)	95A8994
Rack-mounting hardware kit	90AZ8100

Ethernet Cable, 3' (1)	95B15103
AA alkaline batteries (2)	80B8201

Handheld Systems

Handheld Transmitter	ULXD2
Cartridge	see options below
Microphone Clip	95T9279
Zipper Bag	95B2313

Choice of one (1) of the following:

SM58	RPW112
SM86	RPW114
SM87A	RPW116
Beta 58A	RPW118
Beta 87A	RPW120
Beta 87C	RPW122
KSM8 Nickel	RPW170
KSM8 Black	RPW174
KSM9	RPW184
KSM9HS	RPW186

Bodypack System

Bodypack Transmitter	ULXD1
Antenna	95G9043
Carrying/Storage Bag	95A2313

Choice of one (1) of the following:

Cable, Instrument, 2.5 foot (.75 m), 4 Pin Mini Connector (TA4F) to 1/4-inch Connector.	WA302
Instrument Clip-on microphone	Beta 98H/C
Lavalier microphone	MX150, MX153, WL183, WL184, WL185
Cable, Instrument, 2-foot (0.7m), 4-pin Mini Connector (TA4F) with Right-Angle 1/4-inch Connector, used with Shure Wireless Bodypack Transmitters	WA304

Premium Guitar Cable TQG Latching Connector	WA306
Premium 1/4" Right-Angle	WA307
LEMO to 1/4"	WA308
LEMO to 1/4" Right-Angle	WA309

Antennas

Band	1/2-Wave Receiver Antennas	1/4-Wave Transmitter Antennas
G50	95AA9279	95G9043 (Yellow)
G51	95AA9279	95G9043 (Yellow)
G52	95AA9279	95G9043 (Yellow)
H51	95AL9279	95D9043 (Gray)
H52	95AL9279	95D9043 (Gray)
J50	95AK9279	95E9043 (Black)
K51	95AJ9279	95E9043 (Black)
L50	95AD9279	95E9043 (Black)
L51	95AD9279	95E9043 (Black)
P51	95AF9279	95F9043 (Blue)
R51	95M9279	95F9043 (Blue)
AB	95M9279	N/A
Q51	95M9279	N/A

Optional Accessories

Shure Lithium-Ion Rechargeable Battery.	SB900B
8-Bay Shure Battery Charger	SBC800
Dual Docking Charger, Power Supply Not Included	SBC200
Boundary Transmitter	ULXD6
Gooseneck-Base Transmitter	ULXD8
4-bay networked docking station for gooseneck and boundary microphones	SBC450
8-bay networked docking station for gooseneck and boundary microphones	SBC850
Carrying Case	WA610
Y-Cable for bodypack transmitters	AXT652

Antenna UHF-R 470-952 MHz	UA845SWB
Passive Antenna/Splitter Combiner Kit (recommended for 2 receivers)	UA221
In-Line Antenna Amplifier, 470-698MHz	UA830USTV
UHF Antenna Power Distribution Amplifier (USA)	UA844SWB
UHF Antenna Power Distribution Amplifier (Europe)	UA844SE
In-Line Power Supply	UABIAST
Front Mount Antenna Kit (Includes 2 Cables And 2 Bulkhead)	UA600
1/2 Wave Antenna Remote Mount Kit	UA505
Active Directional Antenna 470-900MHZ	UA874WB
Passive Directional Antenna 470-952 MHz. Includes 10 foot BNC to BNC cable.	PA805SWB
2 ft. BNC-BNC Coaxial Cable	UA802
6 foot (1.8m) BNC to BNC Coaxial Cable for Remote Antenna Mounting for ULX Wireless System	UA806
25 ft. BNC-BNC Coaxial Cable	UA825
50 ft. BNC-BNC Coaxial Cable	UA850
100 ft. BNC-BNC Coaxial Cable	UA8100
Short Rack Bar	53A8611
Rackmount Bracket, Long	53A38729
Link Bars (Bracket)	53B8443
Single Rack Mount Kit	RPW503
Dual Rack Mount Kit	RPW504
Black Bodypack Pouch	WA582B

Specifications

ULX-D System Specifications

RF Carrier Frequency Range

470–932 MHz, varies by region (See Frequency Range and Output Power table)

Working Range

100 m (330 ft)

Note: Actual range depends on RF signal absorption, reflection and interference. Note: Actual range depends on RF signal absorption, reflection and interference.

RF Tuning Step Size

25 kHz, varies by region

Image Rejection

>70 dB, typical

RF Sensitivity

-98 dBm

at 10^{-5} BER

Latency

<2.9 ms

Audio Dynamic Range

A-weighted, typical, System Gain @ +10

XLR Analog Output	>120 dB
Dante Digital Output	130 dB

Total Harmonic Distortion

-12 dBFS input, System Gain @ +10

<0.1%

System Audio Polarity

Positive pressure on microphone diaphragm produces positive voltage on pin 2 (with respect to pin 3 of XLR output) and the tip of the 6.35 mm (1/4-inch) output.

Operating Temperature Range

-18°C (0°F) to 50°C (122°F)

Note: Battery characteristics may limit this range.

Storage Temperature Range

-29°C (-20°F) to 74°C (165°F)

Note: Battery characteristics may limit this range.

Receiver Output Level

The following table describes the typical total system gain from the audio input to the receiver outputs:

Receiver Output Gain

Output Jack	System Gain (gain control = 0dB)
1/4" TRS	+18 dB

Output Jack	System Gain (gain control = 0dB)
XLR (line setting)	+24 dB
XLR (mic setting)	-6 dB*

*This setting matches a typical wired SM58 audio signal level.

ULXD1

Mic Offset Range

0 to 21 dB (in 3 dB steps)

Audio Frequency Response

20 – 20 kHz (± 1 dB)

Battery Type

Shure SB900B Rechargeable Li-Ion or LR6 AA batteries 1.5 V

Battery Runtime

@ 10 mW

Shure SB900B	>8 hours
alkaline	9 hours

See Battery Runtime Chart

Dimensions

86 mm x 66 mm x 23 mm (3.4 in. x 2.6 in. x 0.9 in.) H x W x D

Weight

142 g (5.0 oz.), without batteries

Housing

Cast aluminum

Audio Input

Connector

4-Pin male mini connector (TA4M), See drawing for details

Configuration

Unbalanced

Impedance

1 M Ω , See drawing for details

Maximum Input Level

1 kHz at 1% THD

Pad Off	8.5 dBV (7.5 Vpp)
Pad On	20.5 dBV (30 Vpp)

Preamplifier Equivalent Input Noise (EIN)

System Gain Setting \geq +20-120 dBV, A-weighted, typical

RF Output

Connector

SMA

Antenna Type

1/4 wave

Impedance

50 Ω

Occupied Bandwidth

<200 kHz

Modulation Type

Shure proprietary digital

Power

1 mW, 10 mW, 20 mW

See Frequency Range and Output Power table, varies by region

ULXD2

Mic Offset Range

0 to 21 dB (in 3 dB steps)

Audio Frequency Response

Note: Dependent on microphone type

Battery Type

Shure SB900B Rechargeable Li-Ion or LR6 AA batteries 1.5 V

Battery Runtime

@ 10 mW

Shure SB900B	>8 hours
alkaline	9 hours

See Battery Runtime Chart

Dimensions

VHF V50 and V51	278 mm x 51 mm (10.9 in. x 2.0 in.) L x Dia.
Other frequency bands	256 mm x 51 mm (10.1 in. x 2.0 in.) L x Dia.

Weight

VHF V50 and V51	348 g (12.3 oz.), without batteries
Other frequency bands	340 g (12.0 oz.), without batteries

Housing

Machined aluminum

Audio Input

Configuration

Unbalanced

Maximum Input Level

1 kHz at 1% THD 145 dB SPL (SM58), typical

Note: Dependent on microphone type

RF Output

Antenna Type

Integrated Single Band Helical

Occupied Bandwidth

<200 kHz

Modulation Type

Shure proprietary digital

Power

1 mW, 10 mW, 20 mW

See Frequency Range and Output Power table, varies by region

Tables and Diagrams

TA4M Connector

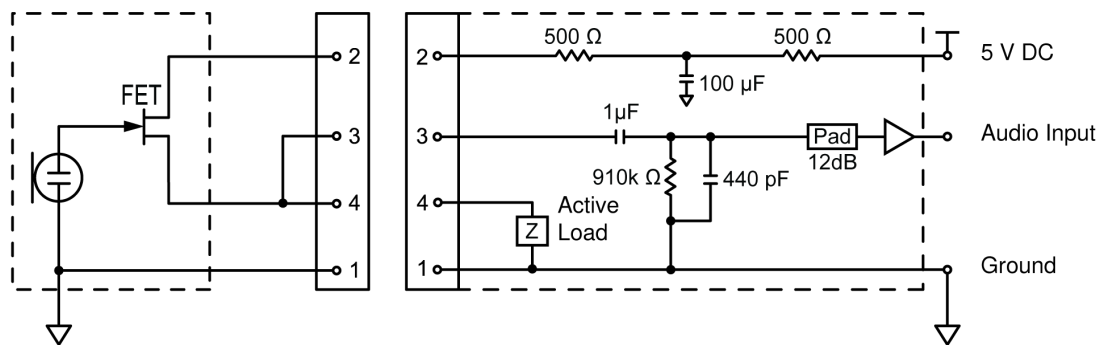

LEMO Connector

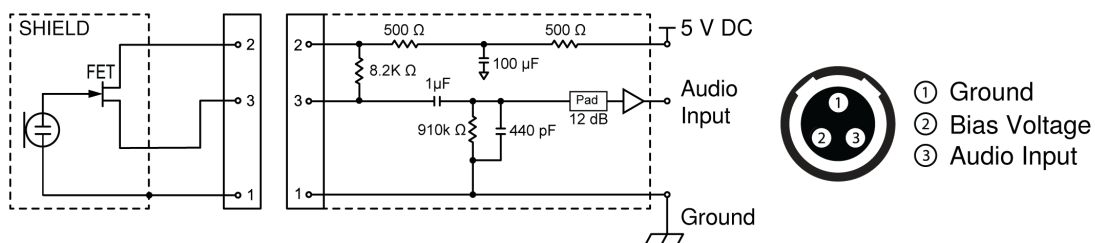

XLR to 1/4 Output

Use the following wiring diagram to convert the XLR output to a 1/4 output.

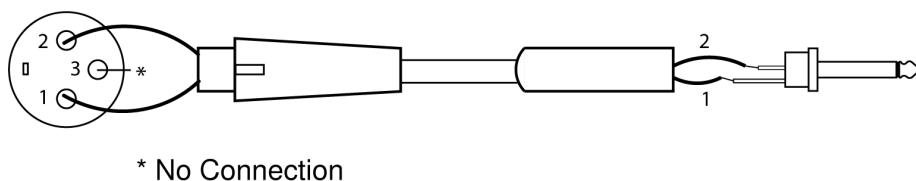

Batteries

ULXD Battery Life

MHz	hours			
	SB900B		alkaline	
	1/10 mW	20 mW	1/10 mW	20 mW
470 to 810	>8:30	>5:40	>8	>5:30
902 to 928	>7:30	>4:40	>7	>4
174 to 216	>8:30	>6:35	8	>5
1240 to 1800	>8	>6:05	>6	>4:30

Note: The SB900B Shure rechargeable battery uses SBC200, SBC800 and SBC220 chargers.

The values in this table are typical of fresh, high quality batteries. Battery runtime varies depending on the manufacturer and age of the battery.

Frequency Range and Transmitter Output Power

Band	Frequency Range (MHz)	Power (mW RMS)*
		(Lo/Nm/Hi)
G50	470 to 534	1/10/20
G51	470 to 534	1/10/20

Band	Frequency Range (MHz)	Power (mW RMS)* (Lo/Nm/Hi)
G52	479 to 534	1/10
G53	470 to 510	1/10/20
G62	510 to 530	1/10/20
H50	534 to 598	1/10/20
H51	534 to 598	1/10/20
H52	534 to 565	1/10
J50	572 to 636	1/10/20
J50A Δ	572 to 608	1/10/20
J51	572 to 636	1/10/20
K51	606 to 670	1/10
L50	632 to 696	1/10/20
L51	632 to 696	1/10/20
L53	632 to 714	1/10/20
M19	694 to 703	1/10/20
P51	710 to 782	1/10/20
R51	800 to 810	1/10/20
JB (Tx only)	806 to 810	1/10
AB (Rx and Tx)	770 to 810	A Band (770-805): 1/10/20
		B Band (806-809): 1/10
Q12	748 to 758	1/10/20
Q51	794 to 806	10
V50	174 to 216	1/10/20
V51	174 to 216	1/10/20
V52	174 to 210	10
X50	925 to 932	1/10
X51	925 to 937.5	10
X52	902 to 928	0.25/10/20
X53	902 to 907.500, 915 to 928	0.25/10/20

Band	Frequency Range (MHz)	Power (mW RMS)* (Lo/Nm/Hi)
X54	915 to 928	0.25/10/20
Z16	1240 to 1260	1/10/20
Z17	1492 to 1525	1/10/20
Z18	1785 to 1805	1/10/20
Z19	1785 to 1800	1/10/20
Z20	1790 to 1805	1/10/20

△ Output power limited to 10 mW above 608 MHz.

Note: Frequency bands might not be available for sale or authorized for use in all countries or regions.

* Power delivered to the antenna port

For the band Z17 (1492-1525 MHz), it must be used indoors only.

For the Band Z19 (1785-1800MHz) used in Australia, per Radio Communications Low Interference Potential Devices Class License 2015; item 30 note C: the system must be operated within the range of 1790-1800MHz when used outdoors.

低功率射頻器材技術規範

取得審驗證明之低功率射頻器材，非經核准，公司、商號或使用者均不得擅自變更頻率、加大功率或變更原設計之特性及功能。低功率射頻器材之使用不得影響飛航安全及干擾合法通信；經發現有干擾現象時，應立即停用，並改善至無干擾時方得繼續使用。前述合法通信，指依電信管理法規定作業之無線電通信。低功率射頻器材須忍受合法通信或工業、科學及醫療用電波輻射性電機設備之干擾。

เครื่องโทรคมนาคมและอุปกรณ์นี้มีความสอดคล้องตามมาตรฐานหรือข้อกำหนดทางเทคนิคของ กสทช.

Frequencies for European Countries

G51 470-534 MHz

Country Code	Frequency Range
Code de Pays	Gamme de frequences
Codice di paese	Gamme di frequenza
Código de país	Gama de frecuencias
Länder-Kürzel	Frequenzbereich
A, B, BG, CH, CY, CZ, D, DK, EST, F	*

Country Code	Frequency Range
Code de Pays	Gamme de frequences
Codice di paese	Gamme di frequenza
Código de país	Gama de frecuencias
Länder-Kürzel	Frequenzbereich
FIN, GB, GR, H, HR, I, IRL, IS, L, LT	*
M, N, NL, P, PL, RO, S, SK, SLO, TR	*
All other countries	*

* This equipment may be capable of operating on some frequencies not authorized in your region. See [Licensing Information](#).

H51 534-598 MHz

Country Code	Frequency Range
Code de Pays	Gamme de frequences
Codice di paese	Gamme di frequenza
Código de país	Gama de frecuencias
Länder-Kürzel	Frequenzbereich
A, B, BG, CH, CY, CZ, D, EST	534 - 598 MHz*
F, GB, GR, H, I, IS, L, LT	534 - 598 MHz*
NL, P, PL, S, SK, SLO	534 - 598 MHz*
DK, FIN, M, N	*
HR, E, IRL, LV, RO, TR	*
All other countries	*

* This equipment may be capable of operating on some frequencies not authorized in your region. See [Licensing Information](#).

K51 606-670 MHz

Country Code	Frequency Range
Code de Pays	Gamme de frequences
Codice di paese	Gamme di frequenza
Código de país	Gama de frecuencias
Länder-Kürzel	Frequenzbereich
A, B, BG, CH, CY, CZ, D, EST	606 - 670 MHz*
F, GB, GR, H, I, IS, L, LT	606 - 670 MHz*
NL, P, PL, S, SK, SLO	606 - 670 MHz*
RO	646 - 647; 654 - 655; 662 - 663 MHz*
DK, E, FIN, HR, IRL, LV, M, N, TR	*
All other countries	*

* This equipment may be capable of operating on some frequencies not authorized in your region. See [Licensing Information](#).

L52 632-694 MHz

Country Code	Frequency Range
Code de Pays	Gamme de frequences
Codice di paese	Gamme di frequenza
Código de país	Gama de frecuencias
Länder-Kürzel	Frequenzbereich
A, B, BG, CH, CY, CZ, D, DK, EST, F	*
FIN, GB, GR, H, HR, I, IRL, IS, L, LT	*
M, N, NL, P, PL, RO, S, SK, SLO, TR	*
All other countries	*

* This equipment may be capable of operating on some frequencies not authorized in your region. See [Licensing Information](#).

P51 710-782 MHz

Country Code	Frequency Range
Code de Pays	Gamme de frequences
Codice di paese	Gamme di frequenza
Código de país	Gama de frecuencias
Länder-Kürzel	Frequenzbereich
A, B, BG, CH, CY, CZ, D, EST, F, GB	710 - 782 MHz*
GR, H, I, IS, L, LT, NL, P, PL, S, SK, SLO	710 - 782 MHz*
RO	718 - 719; 726 - 727; 734 - 743; 750 - 751; 758 - 759 MHz*
DK, E, FIN, HR, IRL, LV, M, N, TR	*
All other countries	*

* This equipment may be capable of operating on some frequencies not authorized in your region. See [Licensing Information](#).

Q51 794-806 MHz

Country Code	Frequency Range
Code de Pays	Gamme de frequences
Codice di paese	Gamme di frequenza
Código de país	Gama de frecuencias
Länder-Kürzel	Frequenzbereich
A, B, BG, CH, CY, CZ, D, DK, E, EST	*
F, FIN, GB, GR, H, HR, I, IRL, IS, L, LT	*
LV, M, N, NL, P, PL, S, SK, SLO, TR	*
All other countries	*

* This equipment may be capable of operating on some frequencies not authorized in your region. See [Licensing Information](#).

R51 800-810 MHz

Country Code	Frequency Range
Code de Pays	Gamme de frequences
Codice di paese	Gamme di frequenza
Código de país	Gama de frecuencias
Länder-Kürzel	Frequenzbereich
N	800 - 810 MHz*
A, B, BG, CH, CY, CZ, D, DK, E, EST	*
F, FIN, GB, GR, H, HR, I, IRL, IS, L, LT	*
LV, M, N, NL, P, PL, S, SK, SLO, TR	*
All other countries	*

* This equipment may be capable of operating on some frequencies not authorized in your region. See [Licensing Information](#).

S50 823-832 MHz, 863-865 MHz

Country Code	Frequency Range
Code de Pays	Gamme de frequences
Codice di paese	Gamme di frequenza
Código de país	Gama de frecuencias
Länder-Kürzel	Frequenzbereich
D	license free
A, B, BG, CH, CY, CZ, D, DK, EST, F	*
FIN, GB, GR, H, HR, I, IRL, IS, L, LT	*
M, N, NL, P, PL, RO, S, SK, SLO, TR	*
863 - 865 MHz	EU: license free
All other countries	*

* This equipment may be capable of operating on some frequencies not authorized in your region. See [Licensing Information](#).

V51 174-216 MHz

Country Code	Frequency Range
Code de Pays	Gamme de frequences
Codice di paese	Gamme di frequenza
Código de país	Gama de frecuencias
Länder-Kürzel	Frequenzbereich
A, B, BG, CH, CY, CZ, D, DK, E, EST	*
F, FIN, GB, GR, H, HR, I, IRL, IS, L, LT	*
LV, M, N, NL, P, PL, S, SK, SLO, TR	*
All other countries	*

* This equipment may be capable of operating on some frequencies not authorized in your region. See [Licensing Information](#).

Z17 1492-1525 MHz

Country Code	Frequency Range
Code de Pays	Gamme de frequences
Codice di paese	Gamme di frequenza
Código de país	Gama de frecuencias
Länder-Kürzel	Frequenzbereich
A, B, BG, CH, CY, CZ, D, DK, E, EST	*
F, FIN, GB, GR, H, HR, I, IRL, IS, L, LT	*
LV, M, N, NL, P, PL, S, SK, SLO, TR	*
This Wireless microphone operates on the range of 1492-1525 MHz. Should be used INDOORS ONLY.	
All other countries	*

* This equipment may be capable of operating on some frequencies not authorized in your region. See [Licensing Information](#).

Z18 1785-1805 MHz

Country Code	Frequency Range
Code de Pays	Gamme de frequences
Codice di paese	Gamme di frequenza
Código de país	Gama de frecuencias
Länder-Kürzel	Frequenzbereich
A, B, BG, CH, CY, CZ, D, DK, E, EST	*
F, FIN, GB, GR, H, HR, I, IRL, IS, L, LT	*
LV, M, N, NL, P, PL, S, SK, SLO, TR	*
All other countries	*

* This equipment may be capable of operating on some frequencies not authorized in your region. See [Licensing Information](#).

IMPORTANT SAFETY INSTRUCTIONS









1. READ these instructions.
2. KEEP these instructions.
3. HEED all warnings.
4. FOLLOW all instructions.
5. DO NOT use this apparatus near water.
6. CLEAN ONLY with dry cloth.
7. DO NOT block any ventilation openings. Allow sufficient distances for adequate ventilation and install in accordance with the manufacturer's instructions.
8. DO NOT install near any heat sources such as open flames, radiators, heat registers, stoves, or other apparatus (including amplifiers) that produce heat. Do not place any open flame sources on the product.
9. DO NOT defeat the safety purpose of the polarized or grounding type plug. A polarized plug has two blades with one wider than the other. A grounding type plug has two blades and a third grounding prong. The wider blade or the third prong are provided for your safety. If the provided plug does not fit into your outlet, consult an electrician for replacement of the obsolete outlet.
10. PROTECT the power cord from being walked on or pinched, particularly at plugs, convenience receptacles, and the point where they exit from the apparatus.
11. ONLY USE attachments/accessories specified by the manufacturer.
12. USE only with a cart, stand, tripod, bracket, or table specified by the manufacturer, or sold with the apparatus. When a cart is used, use caution when moving the cart/apparatus combination to avoid injury from tip-over.



13. UNPLUG this apparatus during lightning storms or when unused for long periods of time.

14. REFER all servicing to qualified service personnel. Servicing is required when the apparatus has been damaged in any way, such as power supply cord or plug is damaged, liquid has been spilled or objects have fallen into the apparatus, the apparatus has been exposed to rain or moisture, does not operate normally, or has been dropped.
15. DO NOT expose the apparatus to dripping and splashing. DO NOT put objects filled with liquids, such as vases, on the apparatus.
16. The MAINS plug or an appliance coupler shall remain readily operable.
17. The airborne noise of the Apparatus does not exceed 70dB (A).
18. Apparatus with CLASS I construction shall be connected to a MAINS socket outlet with a protective earthing connection.
19. To reduce the risk of fire or electric shock, do not expose this apparatus to rain or moisture.
20. Do not attempt to modify this product. Doing so could result in personal injury and/or product failure.
21. Operate this product within its specified operating temperature range.

Explanation of Symbols

	Caution: risk of electric shock
	Caution: risk of danger (See note.)
	Direct current
	Alternating current
	On (Supply)
	Equipment protected throughout by DOUBLE INSULATION or REINFORCED INSULATION
	Stand-by
	Equipment should not be disposed of in the normal waste stream

WARNING: Voltages in this equipment are hazardous to life. No user-serviceable parts inside. Refer all servicing to qualified service personnel. The safety certifications do not apply when the operating voltage is changed from the factory setting.

WARNING: Danger of explosion if incorrect battery replaced. Operate only with AA batteries.

Note: Use only with the included power supply or a Shure-approved equivalent.

WARNING

- Battery packs may explode or release toxic materials. Risk of fire or burns. Do not open, crush, modify, disassemble, heat above 140°F (60°C), or incinerate.
- Follow instructions from manufacturer
- Only use Shure charger to recharge Shure rechargeable batteries
- **WARNING:** Danger of explosion if battery incorrectly replaced. Replace only with same or equivalent type.
- Never put batteries in mouth. If swallowed, contact your physician or local poison control center
- Do not short circuit; may cause burns or catch fire
- Do not charge or use battery packs other than Shure rechargeable batteries
- Dispose of battery packs properly. Check with local vendor for proper disposal of used battery packs.
- Batteries (battery pack or batteries installed) shall not be exposed to excessive heat such as sunshine, fire or the like
- Do not immerse the battery in liquid such as water, beverages, or other fluids.
- Do not attach or insert battery with polarity reversed.
- Keep away from small children.

- Do not use abnormal batteries.
- Pack the battery securely for transport.

Important Product Information

LICENSING INFORMATION

Licensing: A ministerial license to operate this equipment may be required in certain areas. Consult your national authority for possible requirements. Changes or modifications not expressly approved by Shure Incorporated could void your authority to operate the equipment. Licensing of Shure wireless microphone equipment is the user's responsibility, and licensability depends on the user's classification and application, and on the selected frequency. Shure strongly urges the user to contact the appropriate telecommunications authority concerning proper licensing, and before choosing and ordering frequencies.

Note: EMC conformance testing is based on the use of supplied and recommended cable types. The use of other cable types may degrade EMC performance.

Australia Warning for Wireless

This device operates under an ACMA class licence and must comply with all the conditions of that licence including operating frequencies. Before 31 December 2014, this device will comply if it is operated in the 520-820 MHz frequency band.

WARNING: After 31 December 2014, in order to comply, this device must not be operated in the 694-820 MHz band.

Please follow your regional recycling scheme for batteries, packaging, and electronic waste.

Certifications

Meets essential requirements of the following European Directives:

- WEEE Directive 2012/19/EU, as amended by 2008/34/EC
- RoHS Directive EU 2015/863

Note: Please follow your regional recycling scheme for batteries and electronic waste

This product meets the Essential Requirements of all relevant European directives and is eligible for CE marking.

Hereby, Shure Incorporated declares that the radio equipment is in compliance with Directive 2014/53/EU. The full text of the EU declaration of conformity is available at the following internet address: <http://www.shure.com/europe/compliance>

Authorized European representative:

Shure Europe GmbH

Headquarters Europe, Middle East & Africa

Department: EMEA Approval

Jakob-Dieffenbacher-Str. 12

75031 Eppingen, Germany

Phone: +49-7262-92 49 0

Fax: +49-7262-92 49 11 4

Email: EMEAsupport@shure.de

Certified under FCC Part 15 and FCC Part 74.

Certified by ISED in Canada under RSS-102 and RSS-210.

IC: 616A-ULXD1 G50, 616A-ULXD1 H50, 616A-ULXD1 J50, 616A-ULXD1 L50; 616A-ULXD2 G50, 616A-ULXD2 H50, 616A-ULXD2 J50, 616A-ULXD2 L50, 616A-ULXD1G50S, 616A-ULXD1H50S, 616A-ULXD1J50AS, 616A-ULXD2G50S, 616A-ULXD2H50S, 616A-ULXD2J50AS.

FCC: DD4ULXD1G50, DD4ULXD1H50, DD4ULXD1J50, DD4ULXD1L50; DD4ULXD2G50, DD4ULXD2H50, DD4ULXD2J50, DD4ULXD2L50, DD4ULXD1-G50, DD4ULXD1-H50, DD4ULXD1-J50A, DD4ULXD1-X52, DD4ULXD2-G50, DD4ULXD2-H50, DD4ULXD2-J50A, DD4ULXD2-X52 .

IC: 616A-ULXD1X52, 616A-ULXD2X52

FCC: DD4ULXD1X52, DD4ULXD2X52

IC: 616A-ULXD1V50, 616A-ULXD2V50

FCC: DD4ULXD1V50, DD4ULXD2V50

Note: For transmitters operating in the V50 and V51 bands: nominal free space antenna gain at middle of the band is typically -6 dBi, and rolls off at the band edges an additional -4 dB.

Approved under the Declaration of Conformity (DoC) provision of FCC Part 15.

Conforms to electrical safety requirements based on IEC 60065.

- (一) 本产品符合“微功率短距离无线电发射设备目录和技术要求”的具体条款和使用场景；
- (二) 不得擅自改变使用场景或使用条件、扩大发射频率范围、加大发射功率（包括额外加装射频功率放大器），不得擅自更改发射天线；
- (三) 不得对其他合法的无线电台（站）产生有害干扰，也不得提出免受有害干扰保护；
- (四) 应当承受辐射射频能量的工业、科学及医疗（ISM）应用设备的干扰或其他合法的无线电台（站）干扰；
- (五) 如对其他合法的无线电台（站）产生有害干扰时，应立即停止使用，并采取措施消除干扰后方可继续使用；
- (六) 在航空器内和依据法律法规、国家有关规定、标准划设的射电天文台、气象雷达站、卫星地球站（含测控、测距、接收、导航站）等军民用无线电台（站）、机场等的电磁环境保护区域内使用微功率设备，应当遵守电磁环境保护及相关行业主管部门的规定。

Information to the user

This device complies with part 15 of the FCC Rules. Operation is subject to the following two conditions:

1. This device may not cause harmful interference.
2. This device must accept any interference received, including interference that may cause undesired operation.

Note: This equipment has been tested and found to comply with the limits for a Class B digital device, pursuant to part 15 of the FCC Rules. These limits are designed to provide reasonable protection against harmful interference in a residential installation. This equipment generates uses and can radiate radio frequency energy and, if not installed and used in accordance with the instructions, may cause harmful interference to radio communications. However, there is no guarantee that interference will not occur in a particular installation. If this equipment does cause harmful interference to radio or television reception, which can be determined by turning the equipment off and on, the user is encouraged to try to correct the interference by one or more of the following measures:

- Reorient or relocate the receiving antenna.
- Increase the separation between the equipment and the receiver.
- Connect the equipment to an outlet on a circuit different from that to which the receiver is connected.
- Consult the dealer or an experienced radio/TV technician for help.

This device operates on frequencies shared with other devices. Consult the Federal Communications Commission White Space Database Administration website to determine available channels in your area prior to operation.

No user-operated control of power, frequency, or other parameters are available beyond those specified in this operating manual.

Canada Warning for Wireless

This device operates on a no-protection, no-interference basis. Should the user seek to obtain protection from other radio services operating in the same TV bands, a radio licence is required. For further details, consult Innovation, Science and Economic Development Canada's document Client Procedures Circular CPC-2-1-28, Voluntary Licensing of Licence-Exempt Low-Power Radio Apparatus in the TV Bands.

Ce dispositif fonctionne selon un régime de non-brouillage et de non-protection. Si l'utilisateur devait chercher à obtenir une certaine protection contre d'autres services radio fonctionnant dans les mêmes bandes de télévision, une licence radio serait requise. Pour en savoir plus, veuillez consulter la Circulaire des procédures concernant les clients CPC.2.1.28, Délivrance de licences sur une base volontaire pour les appareils radio de faible puissance exempts de licence et exploités dans les bandes de télévision d'Innovation, Sciences et Développement économique Canada.

This device contains licence-exempt transmitter(s)/receiver(s) that comply with Innovation, Science and Economic Development Canada's licence-exempt RSS(s). Operation is subject to the following two conditions:

1. This device may not cause interference.
2. This device must accept any interference, including interference that may cause undesired operation of the device.

L'émetteur/récepteur exempt de licence contenu dans le présent appareil est conforme aux CNR d'Innovation, Sciences et Développement économique Canada applicables aux appareils radio exempts de licence. L'exploitation est autorisée aux deux conditions suivantes :

1. L'appareil ne doit pas produire de brouillage;
2. L'appareil doit accepter tout brouillage radioélectrique subi, même si le brouillage est susceptible d'en compromettre le fonctionnement.