

■DESCRIPTION

The WS-5325M includes a wireless transmitter WM-5325, a lavalier microphone YP-M5310, and a diversity wireless tuner WT-5810.  
 The WM-5325 wireless transmitter has been manufactured for use with a UHF system. Thanks to the PLL-synthesizer system, 64 different operating frequencies are made available. A high output power ensures stable radio signal transmission.  
 The YP-M5310 employs an electret condenser microphone element and has been designed for use in speech reinforcement applications.  
 The WT-5810 is a PLL-synthesizer controlled double superheterodyne diversity tuner designed to be used with a UHF wireless system. It employs a compander noise reduction circuit to minimize the influence of ambient RF noise.

■SPECIFICATIONS

Product Composition	Wireless transmitter WM-5325 *1, Lavalier microphone YP-M5310 *1, Diversity wireless tuner WT-5810 *1
Frequency Range	576 - 865 MHz (*1), UHF
Tone Frequency	32.768 kHz
Operating Temperature	-10 °C to +50 °C (14 °F to 122 °F)
Accessory	AC adapter (*2) *1, Screw driver *1, Storage case *1, Neck strap *1

Wireless transmitter

(\*3) 0 dB = 1 V

Modulation	Frequency modulation
Channel Selectable	64 channels (the number of channels may differ from country to country)
RF Carrier Power	Less than 50 mW (Factory preset 10 mW ERP)
Oscillator	PLL synthesized
Maximum Input Level	-14 dB to -29 dB (*3) (Audio level control: Min. to Max.)
Battery	WB-2000 (WB-2000-2 contains 2 pieces) rechargeable battery (option) or AA alkaline dry cell battery
Battery Life	Approx. 13 h (when the WB-2000 rechargeable battery is used) Approx. 10 h (when the alkaline battery is used)
Indicator	Power/Battery lamps
Antenna	Built-in type
Finish	Resin, coating
Dimensions	62 (W) × 102.5 (H) × 23 (D) mm (2.44" × 4.04" × 0.91")
Weight	90 g (0.2 lb) (with battery)

Lavalier microphone

Microphone Element	Electret condenser type: Omnidirectional
Sensitivity	-64 dB ±3 dB (0 dB = 1 V/0.1 Pa, 1 kHz)
Cord Length	1.3 m (4.27 ft)
Finish	Dark black
Weight	20 g (0.71 oz) (cable included)

Diversity wireless tuner

(\*3) 0 dB = 1 V





Power Source	AC mains (supplied AC adapter must be used)
Power Consumption	130 mA (12 V DC)
Channel Selectable	16 channels
Receiving System	Double super-heterodyne
Diversity System	Space diversity
Mixing Output	MIC: -60 dB (*3), 600 Ω, balanced, XLR-3-32 type connector LINE: -20 dB (*3), 600 Ω, unbalanced, phone jack
Mixing Input	-20 dB (*3), 10 kΩ, unbalanced, phone jack
Antenna	Whip antenna
Receiving Sensitivity	90 dB or more, Signal to Noise ratio (20 dBμV input, 40 kHz deviation)
Squelch Sensitivity	16 - 40 dBμV variable
Squelch System	Using together of noise SQ, carrier SQ and tone SQ
Indicator	ANT A/B, Audio (peak), Battery alarm, Channel number
Channel Check	Usable frequencies scanning
Signal to Noise Ratio	104 dB or more (A-weight, unbalanced output)
Harmonic Distortion	1 % or less (typical)
Frequency Response	100 Hz - 15 kHz, ±3 dB
Finish	Resin, black
Dimensions	206 (W) × 40.6 (H) × 152.7 (D) mm (8.11" × 1.6" × 6.01") (excluding antenna)
Weight	590 g (1.3 lb)

(\*1)

Version	Receiving Frequency
A01	692 - 722 MHz, UHF
B01, B02	722 - 752 MHz, UHF
C01 - C07	794 - 830 MHz, UHF
D01 - D05	830 - 865 MHz, UHF
E01	668 - 698 MHz, UHF
F01	636 - 666 MHz, UHF
G01, G02	606 - 636 MHz, UHF
H01	576 - 606 MHz, UHF

Note: For Thailand, B02: 748.3 - 757.7 MHz  
C04: 803.3 - 805.7 MHz

(\*2)

Version	AC Adapter	
US	120 V AC, 60 Hz	
CN	220 V AC, 50 Hz	
UK	220 - 230 V AC, 50 Hz	
ER	230 V AC, 50 Hz	
AS	240 V AC, 50 Hz	

Note: No AC adapter is supplied with the version B02ER or C04ER.

■ APPEARANCE

Wireless Transmitter

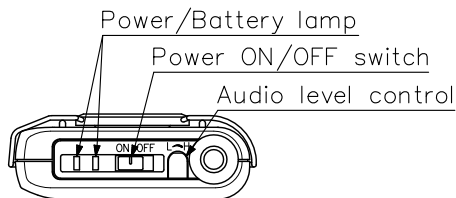

Top View

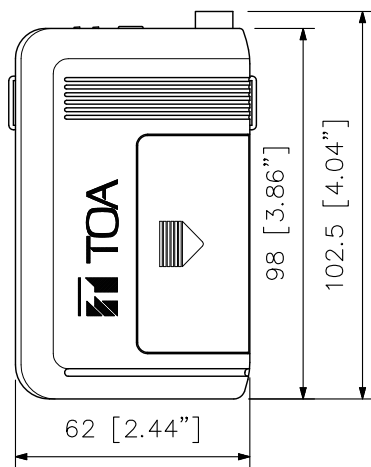

Front View

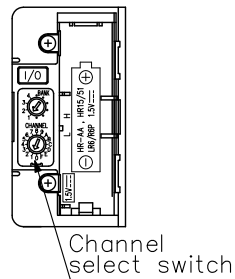

Inside of a battery cover

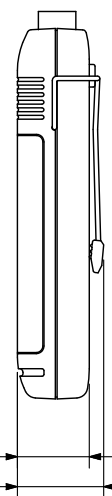

Side View

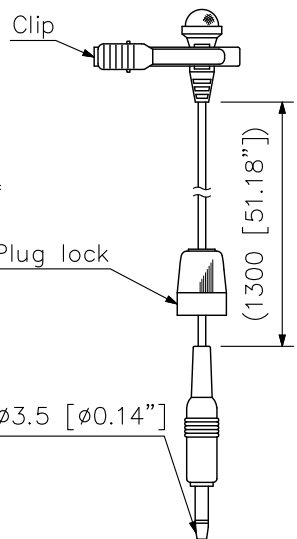

Lavalier Microphone

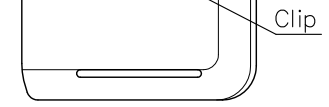

Rear View

UNIT:mm SCALE:1/2

Note: Numerical values in parentheses are for reference only.

■ APPEARANCE

Diversity wireless tuner

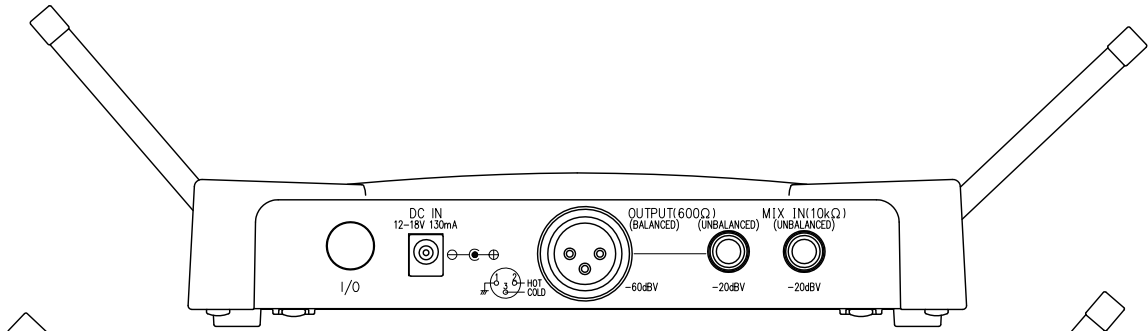

Rear View

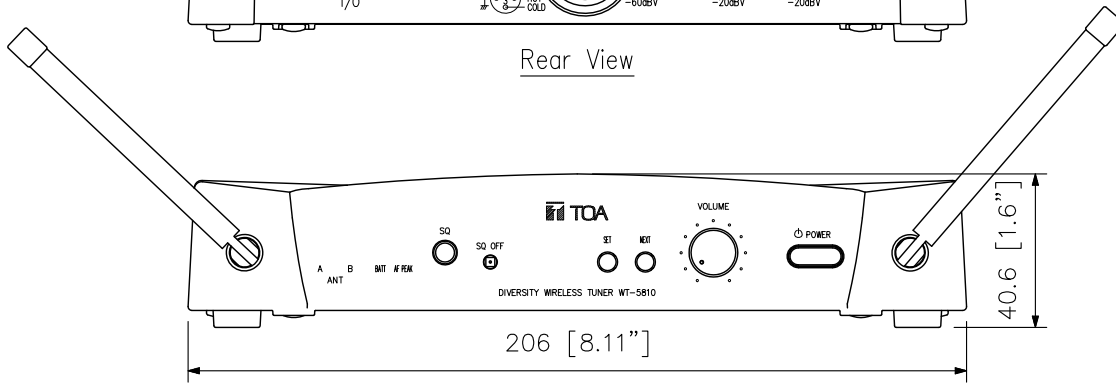

Front View

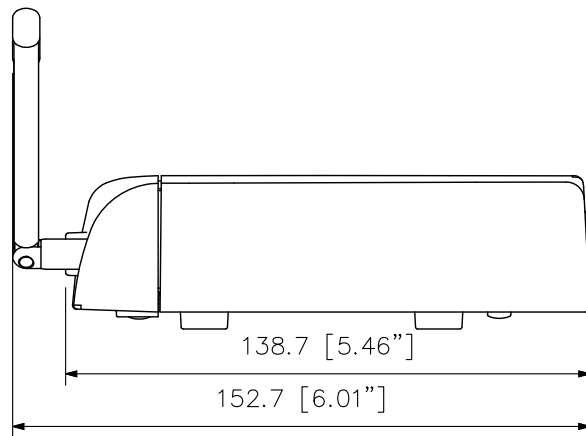

Side View

UNIT: mm SCALE: 1/2